

SMALL SIGNAL SCHOTTKY DIODES

DESCRIPTION

General purpose, metal to silicon diodes featuring very low turn-on voltage fast switching.

These devices have integrated protection against excessive voltage such as electrostatic discharges.

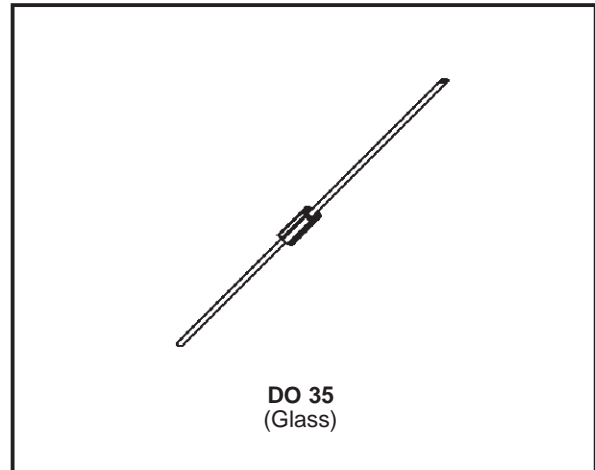

ABSOLUTE RATINGS (limiting values)

Symbol	Parameter		Value	Unit
V_{RRM}	Repetitive Peak Reverse Voltage		30	V
I_F	Forward Continuous Current	$T_a = 25\text{ °C}$	200	mA
I_{FRM}	Repetitive Peak Forward Current	$t_p \leq 1\text{ s}$ $\delta \leq 0.5$	500	mA
I_{FSM}	Surge non Repetitive Forward Current*	$t_p = 10\text{ ms}$	4	A
P_{tot}	Power Dissipation*	$T_l = 65\text{ °C}$	200	mW
T_{stg} T_j	Storage and Junction Temperature Range		- 65 to +150 - 65 to +125	°C °C
T_L	Maximum Temperature for Soldering during 10s at 4mm from Case		230	°C

THERMAL RESISTANCE

Symbol	Test Conditions	Value	Unit
$R_{th(j-a)}$	Junction-ambient*	300	°C/W

* On infinite heatsink with 4mm lead length

ELECTRICAL CHARACTERISTICS

STATIC CHARACTERISTICS

Symbol	Test Conditions		Min.	Typ.	Max.	Unit
V_{BR}	$T_j = 25^\circ\text{C}$	$I_R = 100\mu\text{A}$	30			V
V_F^*	$T_j = 25^\circ\text{C}$	$I_F = 200\text{mA}$	All Types		1	V
	$T_j = 25^\circ\text{C}$	$I_F = 10\text{mA}$	BAT 42		0.4	
	$T_j = 25^\circ\text{C}$	$I_F = 50\text{mA}$			0.65	
	$T_j = 25^\circ\text{C}$	$I_F = 2\text{mA}$	BAT 43		0.33	
	$T_j = 25^\circ\text{C}$	$I_F = 15\text{mA}$			0.45	
I_R^*	$T_j = 25^\circ\text{C}$	$V_R = 25\text{V}$			0.5	μA
	$T_j = 100^\circ\text{C}$				100	

DYNAMIC CHARACTERISTICS

Symbol	Test Conditions		Min.	Typ.	Max.	Unit
C	$T_j = 25^\circ\text{C}$	$V_R = 1\text{V}$ $f = 1\text{MHz}$		7		pF
trr	$T_j = 25^\circ\text{C}$	$I_F = 10\text{mA}$ $I_R = 10\text{mA}$ $i_{rr} = 1\text{mA}$ $R_L = 100\Omega$			5	ns
h	$T_j = 25^\circ\text{C}$	$R_L = 15\text{K}\Omega$ $C_L = 300\text{pF}$ $f = 45\text{MHz}$ $V_i = 2\text{V}$	80			%

* Pulse test: $t_p \leq 300\mu\text{s}$ $\delta < 2\%$.

Figure 1. Forward current versus forward voltage at different temperatures (typical values).

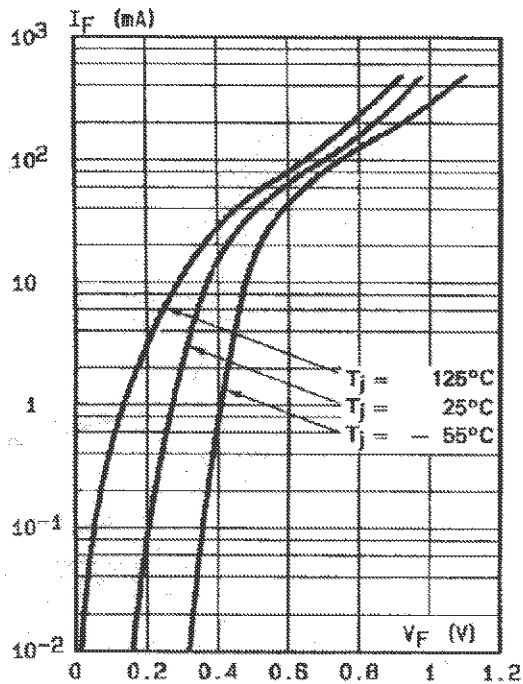

Figure 2. Forward current versus forward voltage (typical values).

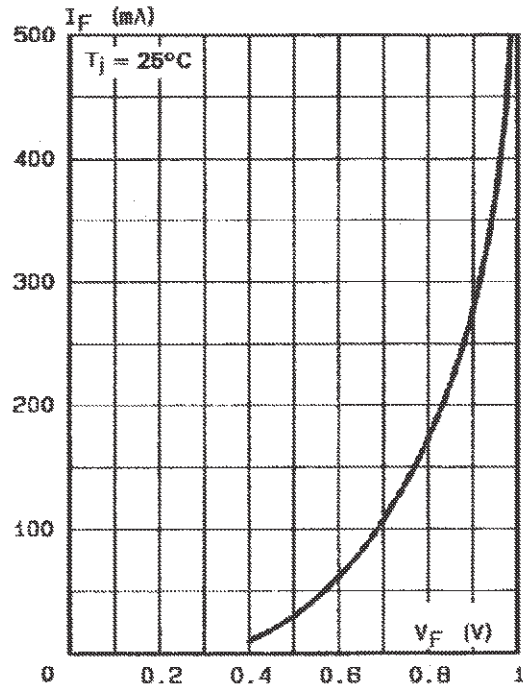

Figure 3. Reverse current versus junction temperature (typical values).

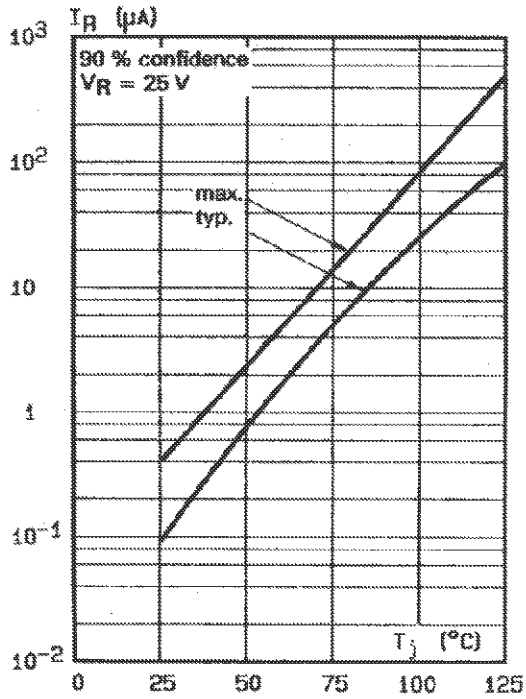

Figure 4. Reverse current versus continuous reverse voltage.

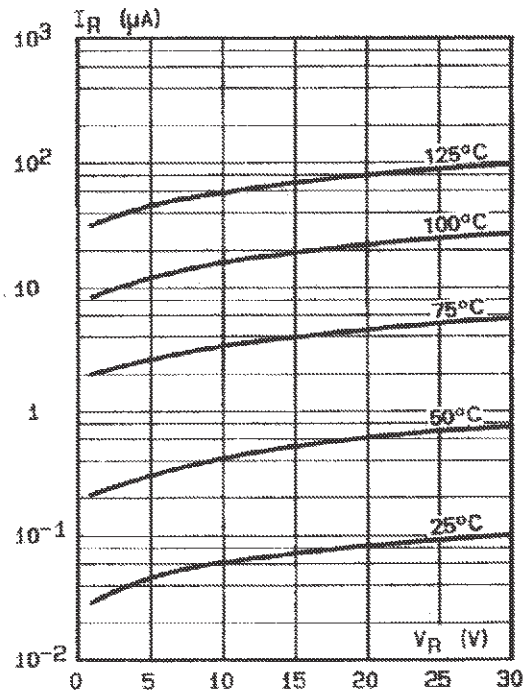
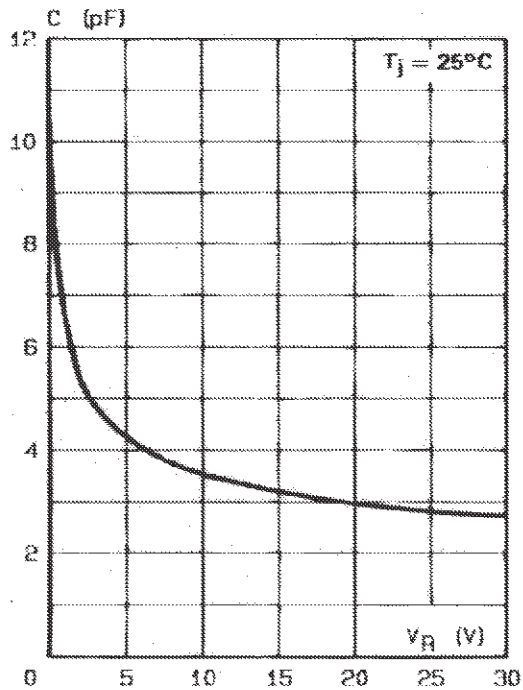

Figure 5. Capacitance C versus reverse applied voltage V_R (typical values).



BAT 42/BAT 43

PACKAGE MECHANICAL DATA

DO 35 Glass

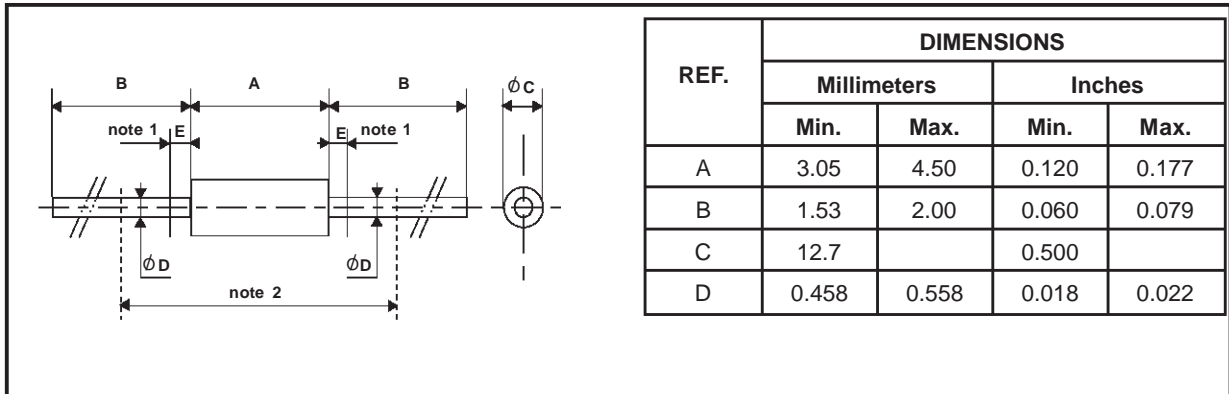

Cooling method: by convection and conduction
Marking: clear, ring at cathode end.
Weight: 0.15g

Information furnished is believed to be accurate and reliable. However, STMicroelectronics assumes no responsibility for the consequences of use of such information nor for any infringement of patents or other rights of third parties which may result from its use. No license is granted by implication or otherwise under any patent or patent rights of STMicroelectronics. Specifications mentioned in this publication are subject to change without notice. This publication supersedes and replaces all information previously supplied. STMicroelectronics products are not authorized for use as critical components in life support devices or systems without express written approval of STMicroelectronics.

The ST logo is a registered trademark of STMicroelectronics
© 1999 STMicroelectronics - Printed in Italy - All rights reserved.

STMicroelectronics GROUP OF COMPANIES
Australia - Brazil - China - Finland - France - Germany - Hong Kong - India - Italy - Japan - Malaysia
Malta - Morocco - Singapore - Spain - Sweden - Switzerland - United Kingdom - U.S.A.

<http://www.st.com>