

Silicon NPN Power Transistors

2SC2168

DESCRIPTION

- With TO-220 package
- High collector-emitter breakdown voltage
: $V_{CEO}=200V(\text{min})$

APPLICATIONS

- Power amplifier applications
- TV vertical deflection applications

PINNING

PIN	DESCRIPTION
1	Base
2	Collector;connected to mounting base
3	Emitter

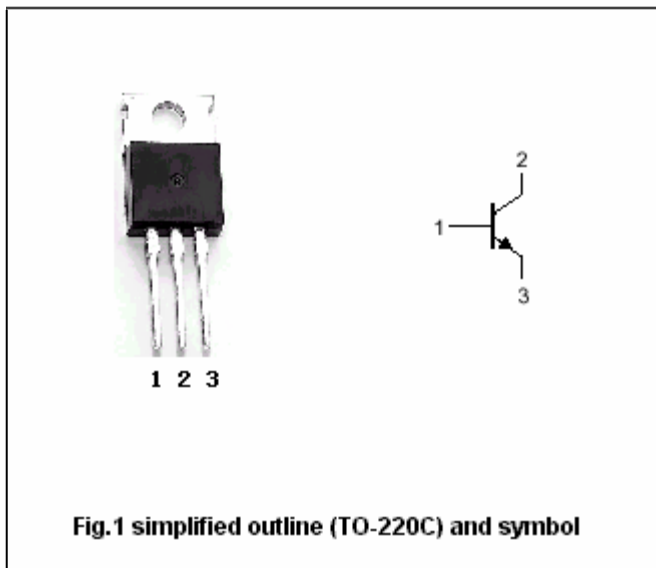

Absolute maximum ratings ($T_a=25^\circ\text{C}$)

SYMBOL	PARAMETER	CONDITIONS	VALUE	UNIT
V_{CBO}	Collector-base voltage	Open emitter	200	V
V_{CEO}	Collector-emitter voltage	Open base	200	V
V_{EBO}	Emitter-base voltage	Open collector	6	V
I_C	Collector current		2	A
I_{CM}	Collector current-peak		3	A
P_C	Collector power dissipation	$T_C=25^\circ\text{C}$	30	W
T_j	Junction temperature		150	$^\circ\text{C}$
T_{stg}	Storage temperature		-55~150	$^\circ\text{C}$

Silicon NPN Power Transistors

2SC2168

CHARACTERISTICS

T_j=25 °C unless otherwise specified

SYMBOL	PARAMETER	CONDITIONS	MIN	TYP.	MAX	UNIT
V _{(BR)CEO}	Collector-emitter breakdown voltage	I _C =25mA ; I _B =0	200			V
V _{(BR)CBO}	Collector-base breakdown voltage	I _C =0.5mA ; I _E =0	200			V
V _{(BR)EBO}	Emitter-base breakdown voltage	I _E =0.5mA ; I _C =0	6			V
V _{CEsat}	Collector-emitter saturation voltage	I _C =0.5A ; I _B =50m A			1.0	V
I _{CBO}	Collector cut-off current	V _{CB} =200V; I _E =0			10	μA
I _{EBO}	Emitter cut-off current	V _{EB} =5V; I _C =0			10	μA
h _{FE}	DC current gain	I _C =0.1A ; V _{CE} =5V	50			
f _T	Transition frequency	I _C =0.1A ; V _{CE} =10V		20		MHz

Silicon NPN Power Transistors

2SC2168

PACKAGE OUTLINE

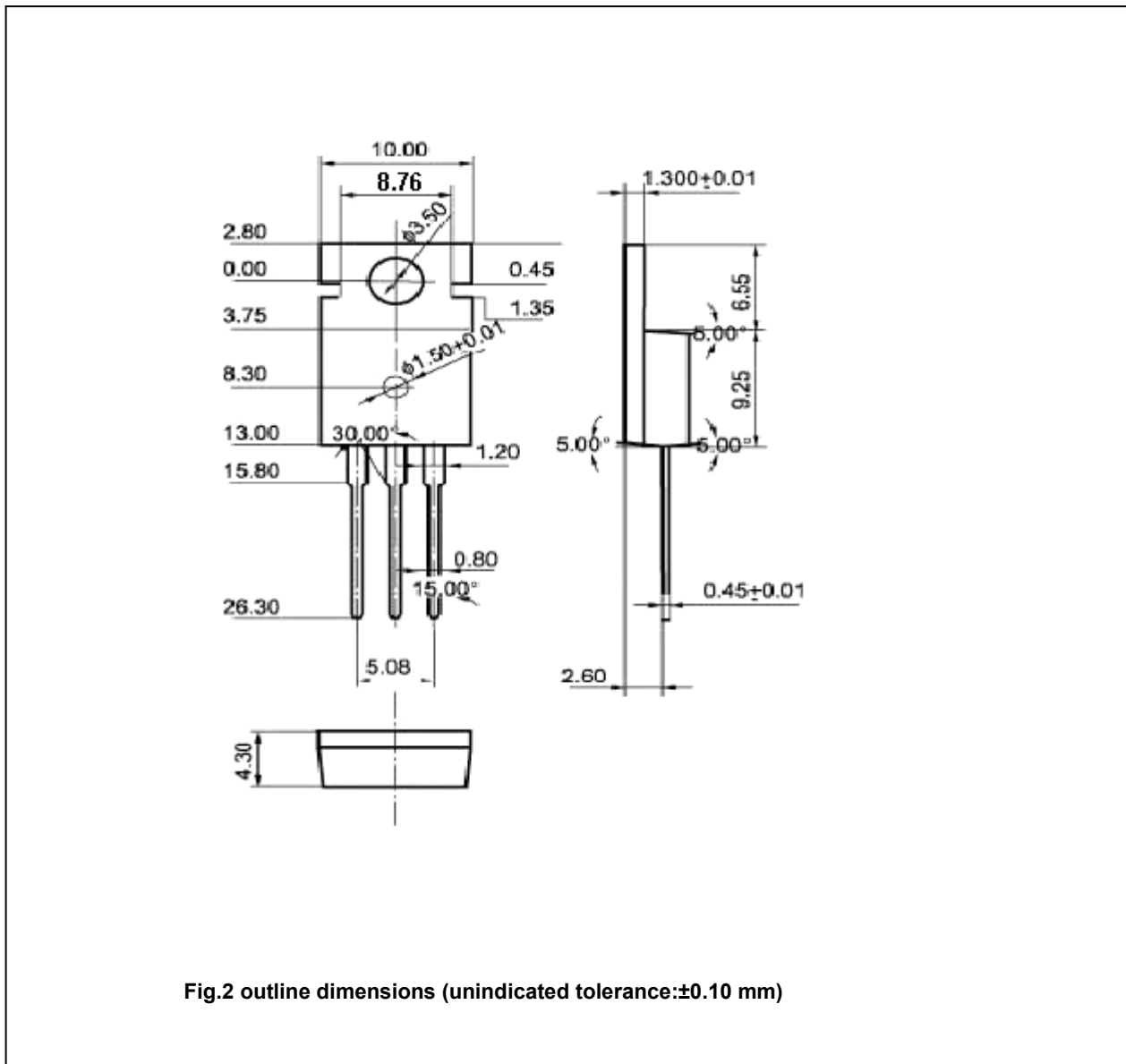

Fig.2 outline dimensions (unindicated tolerance: ± 0.10 mm)