

Silicon NPN Power Transistors

2SC3858

DESCRIPTION

- With MT-200 package
- Complement to type 2SA1494

APPLICATIONS

- Audio and general purpose

PINNING(see Fig.2)

PIN	DESCRIPTION
1	Base
2	Collector;connected to mounting base
3	Emitter

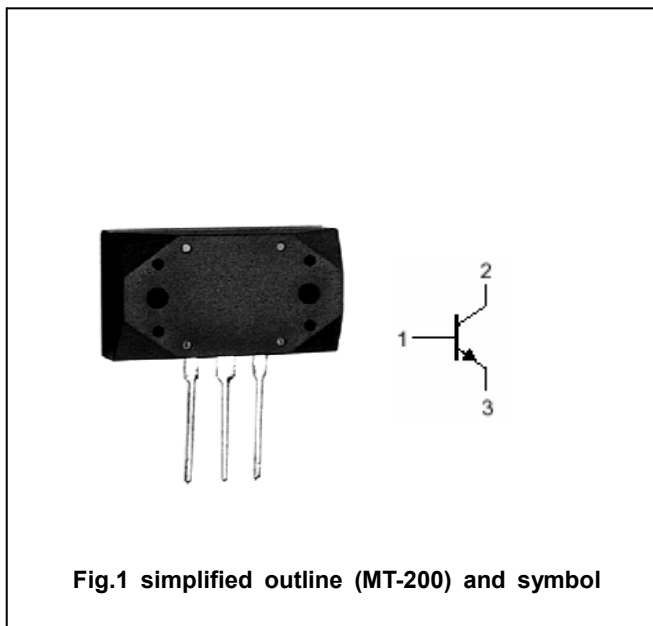

Fig.1 simplified outline (MT-200) and symbol

Absolute maximum ratings (Ta=25°C)

SYMBOL	PARAMETER	CONDITIONS	VALUE	UNIT
V_{CBO}	Collector-base voltage	Open emitter	200	V
V_{CEO}	Collector-emitter voltage	Open base	200	V
V_{EBO}	Emitter-base voltage	Open collector	6	V
I_C	Collector current		17	A
I_B	Base current		5	A
P_C	Collector power dissipation	$T_C=25^\circ$	200	W
T_j	Junction temperature		150	$^\circ$
T_{stg}	Storage temperature		-55~150	$^\circ$

Silicon NPN Power Transistors

2SC3858

CHARACTERISTICS

T_j=25°C unless otherwise specified

SYMBOL	PARAMETER	CONDITIONS	MIN	TYP.	MAX	UNIT
V _{(BR)CEO}	Collector-emitter breakdown voltage	I _C =50mA; I _B =0	200			V
V _{CEsat}	Collector-emitter saturation voltage	I _C =10 A; I _B =1 A			2.5	V
I _{CBO}	Collector cut-off current	V _{CB} =200V; I _E =0			100	μA
I _{EBO}	Emitter cut-off current	V _{EB} =6V; I _C =0			100	μA
h _{FE}	DC current gain	I _C =8A ; V _{CE} =4V	50		180	
f _T	Transition frequency	I _C =1A ; V _{CE} =12V		20		MHz
C _{OB}	Output capacitance	I _E =0; V _{CB} =10V; f=1MHz		300		pF

Switching times

t _{on}	Turn-on time	I _C =10A; R _L =4Ω I _{B1} =- I _{B2} =1A V _{CC} =40V		0.50		μs
t _s	Storage time			1.80		μs
t _f	Fall time			0.60		μs

◆ h_{FE} classifications

Y	P	G
50-100	70-140	90-180

Silicon NPN Power Transistors

2SC3858

PACKAGE OUTLINE

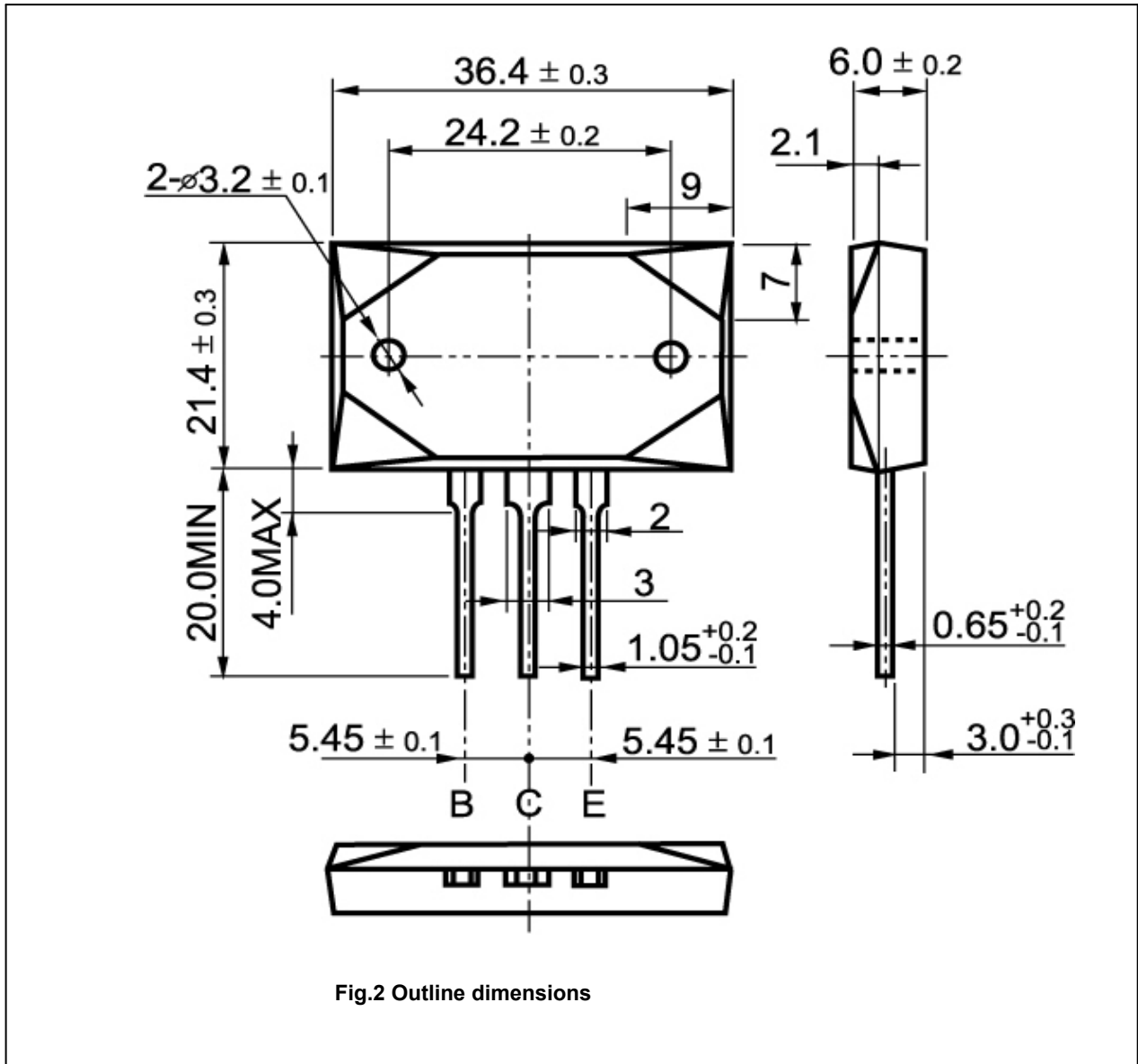

Silicon NPN Power Transistors

2SC3858

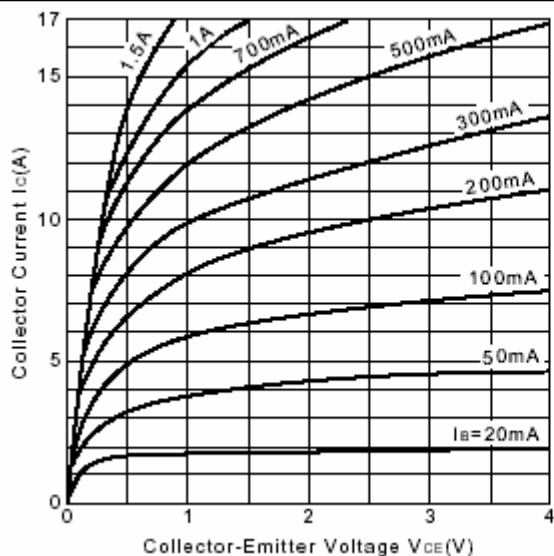

Fig.3 Static Characteristic

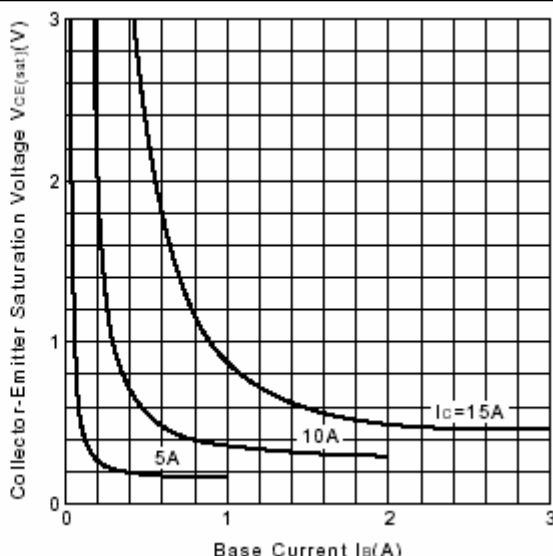

Fig.4 $V_{CE(sat)}$ - I_B Characteristics

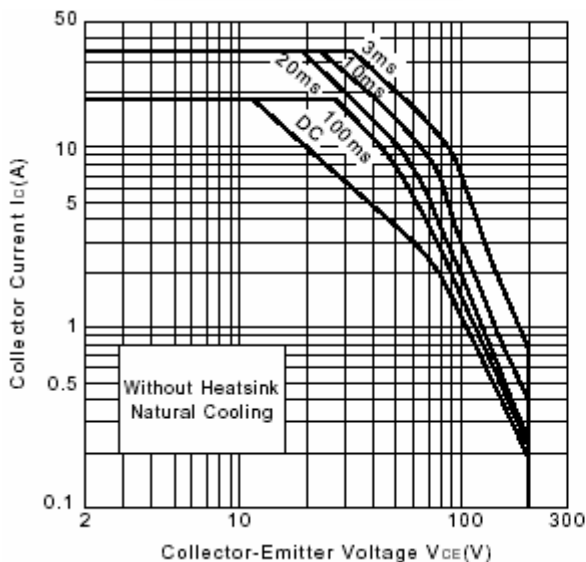

Fig.5 Safe Operating Area

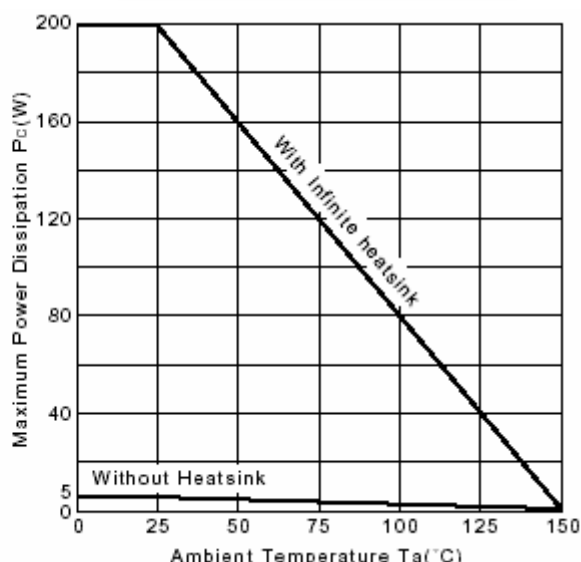

Fig.6 P_c - T_a Derating

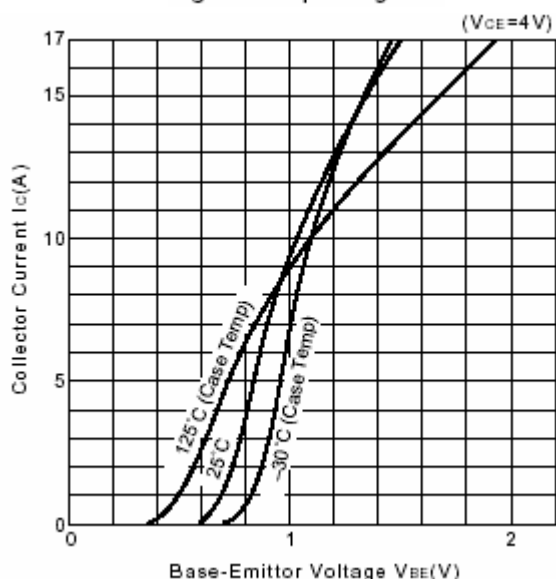

Fig.7 I_C - V_{BE}

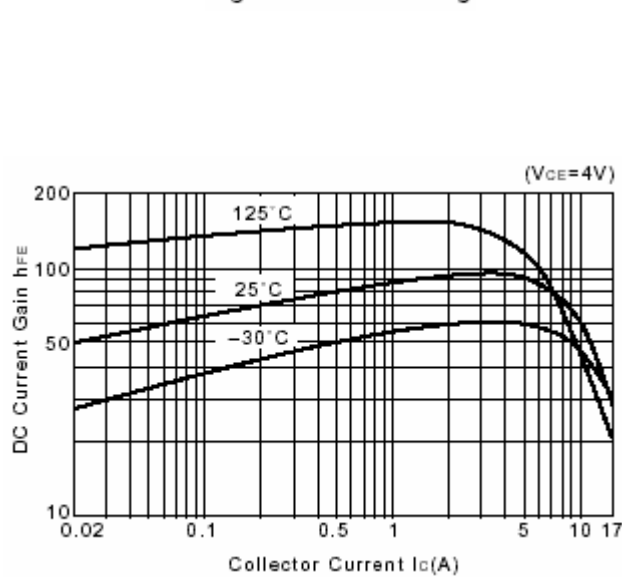

Fig.8 DC current Gain