

**2SC5299**

## Ultrahigh-Definition CRT Display Horizontal Deflection Output Applications

### Features

- High Speed :  $t_f=100\text{ns}$  typ.
- High Breakdown voltage :  $V_{CBO}=1500\text{V}$ .
- High reliability (Adoption of HVP process).
- Adoption of MBIT process.

### Package Dimensions

unit: mm

#### 2039C-TO3PML

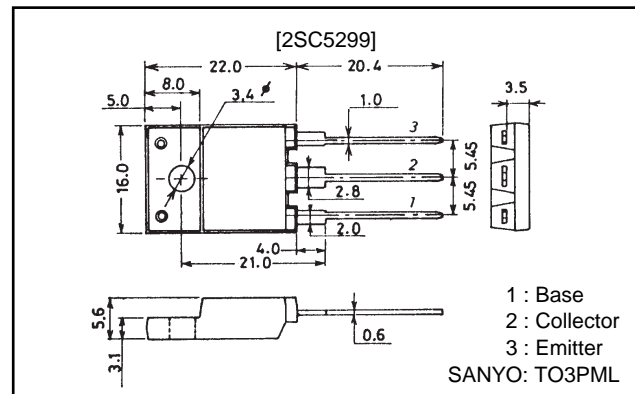

### Specifications

#### Absolute Maximum Ratings at $T_a=25^\circ\text{C}$

Parameter	Symbol	Conditions	Ratings	Unit
Collector-to-Base Voltage	$V_{CBO}$		1500	V
Collector-to-Emitter Voltage	$V_{CEO}$		800	V
Emitter-to-Base Voltage	$V_{EBO}$		6	V
Collector Current	$I_C$		10	A
Collector Current (Pulse)	$I_{CP}$		25	A
Collector Dissipation	$P_C$		3.0	W
		$T_c=25^\circ\text{C}$	70	W
Junction Temperature	$T_j$		150	$^\circ\text{C}$
Storage Temperature	$T_{stg}$		-55 to +150	$^\circ\text{C}$

#### Electrical Characteristics at $T_a=25^\circ\text{C}$

Parameter	Symbol	Conditions	Ratings			Unit
			min	typ	max	
Collector Cutoff Current	$I_{CBO}$	$V_{CB}=800\text{V}$ , $I_E=0$			10	$\mu\text{A}$
Collector Cutoff Current	$I_{CES}$	$V_{CE}=1500\text{V}$ , $R_{BE}=0$			1.0	mA
Collector Sustain Voltage	$V_{CEO(SUS)}$	$I_C=100\text{mA}$ , $I_B=0$	800			V
Emitter Cutoff Current	$I_{EBO}$	$V_{EB}=4\text{V}$ , $I_C=0$			1.0	mA
C-E Saturation Voltage	$V_{CE(sat)}$	$I_C=8\text{A}$ , $I_B=2\text{A}$			5	V
B-E Saturation Voltage	$V_{BE(sat)}$	$I_C=8\text{A}$ , $I_B=2\text{A}$			1.5	V
DC Current Gain	$h_{FE(1)}$	$V_{CE}=5\text{V}$ , $I_C=1\text{A}$	20		30	
	$h_{FE(2)}$	$V_{CE}=5\text{V}$ , $I_C=8\text{A}$	4		7	
Storage Time	$t_{stg}$	$I_C=6\text{A}$ , $I_{B1}=1.2\text{A}$ , $I_{B2}=-2.4\text{A}$			3.0	$\mu\text{s}$
Fall Time	$t_f$	$I_C=6\text{A}$ , $I_{B1}=1.2\text{A}$ , $I_{B2}=-2.4\text{A}$		0.1	0.2	$\mu\text{s}$

Switching Time Test Circuit

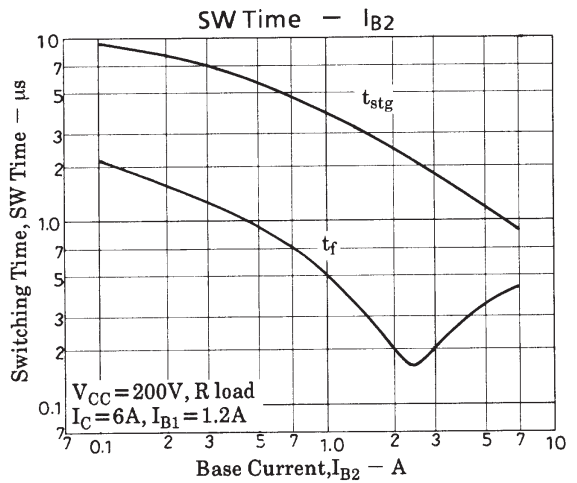
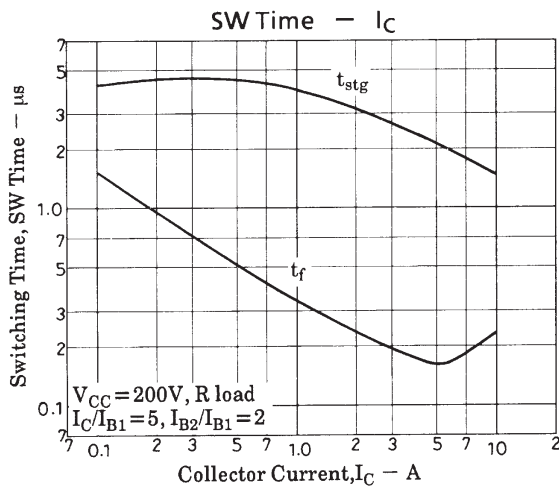
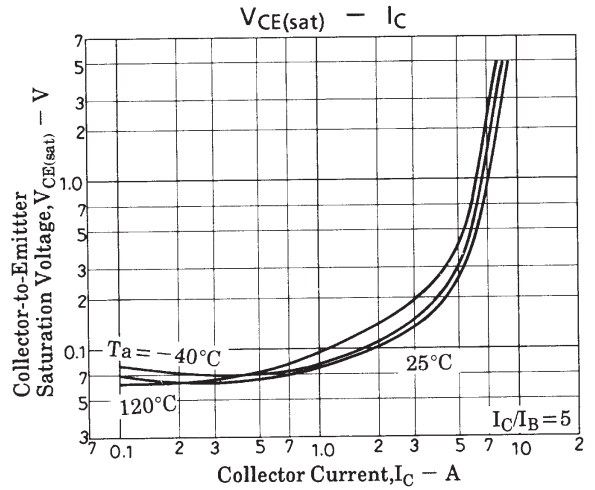
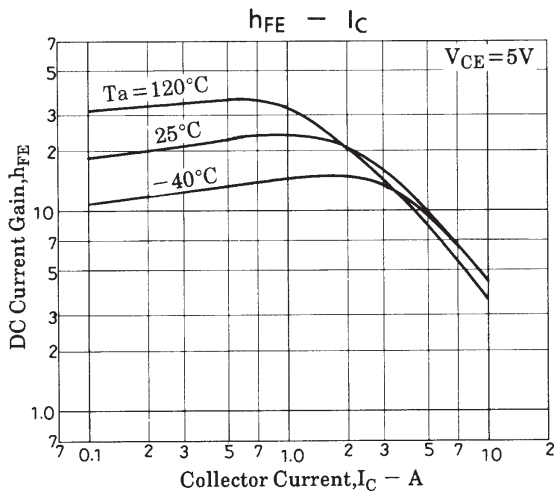
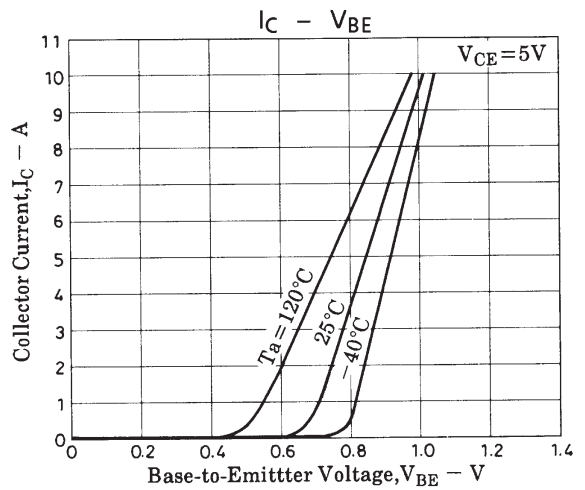
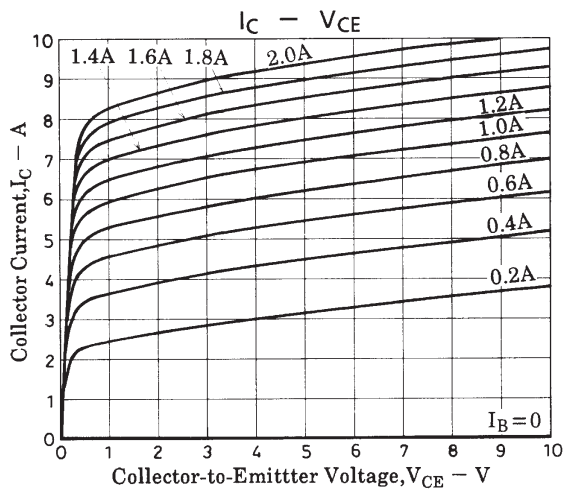
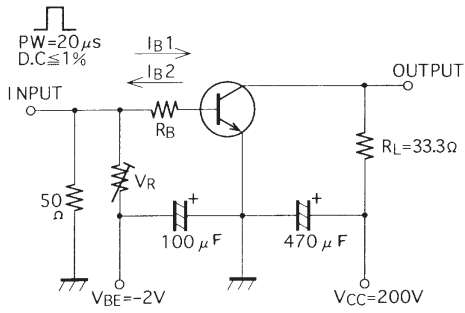

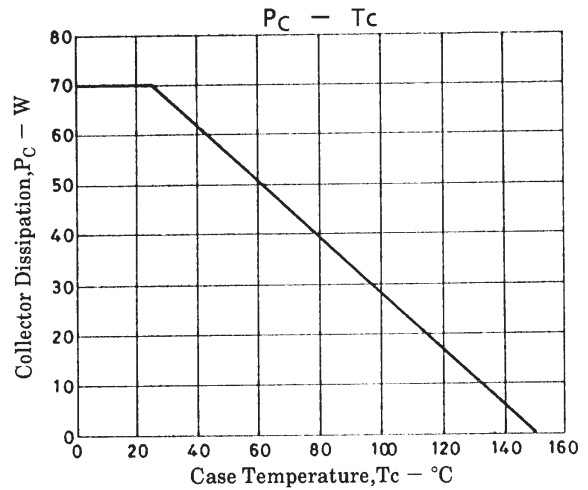
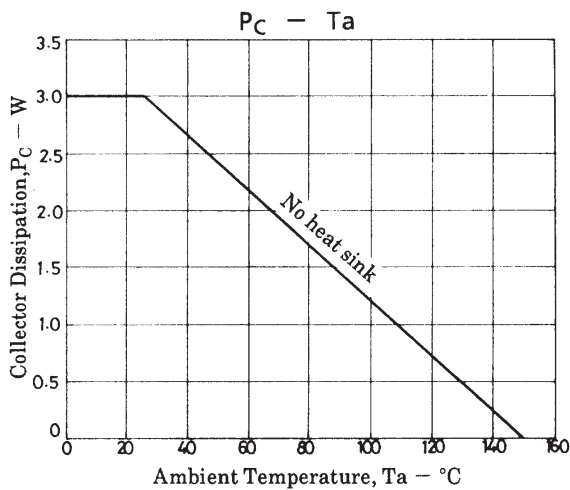
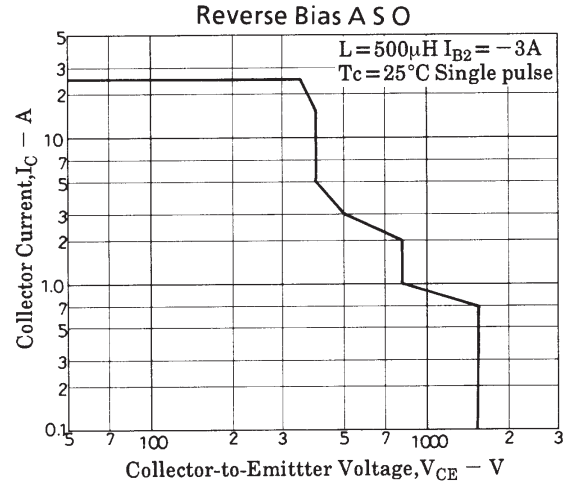
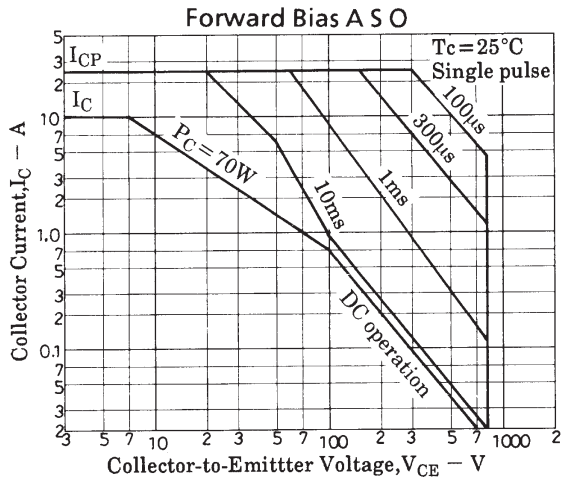

■ No products described or contained herein are intended for use in surgical implants, life-support systems, aerospace equipment, nuclear power control systems, vehicles, disaster/crime-prevention equipment and the like, the failure of which may directly or indirectly cause injury, death or property loss.

■ Anyone purchasing any products described or contained herein for an above-mentioned use shall:

- ① Accept full responsibility and indemnify and defend SANYO ELECTRIC CO., LTD., its affiliates, subsidiaries and distributors and all their officers and employees, jointly and severally, against any and all claims and litigation and all damages, cost and expenses associated with such use:
- ② Not impose any responsibility for any fault or negligence which may be cited in any such claim or litigation on SANYO ELECTRIC CO., LTD., its affiliates, subsidiaries and distributors or any of their officers and employees jointly or severally.

■ Information (including circuit diagrams and circuit parameters) herein is for example only; it is not guaranteed for volume production. SANYO believes information herein is accurate and reliable, but no guarantees are made or implied regarding its use or any infringements of intellectual property rights or other rights of third parties.

This catalog provides information as of January, 1997. Specifications and information herein are subject to change without notice.