

Complementary Silicon High-Power Transistors

... PowerBase complementary transistors designed for high power audio, stepping motor and other linear applications. These devices can also be used in power switching circuits such as relay or solenoid drivers, dc-to-dc converters, inverters, or for inductive loads requiring higher safe operating area than the 2N3055 and MJ2955.

- Current-Gain — Bandwidth-Product @ $I_C = 1.0 \text{ Adc}$
 $f_T = 0.8 \text{ MHz (Min) - NPN}$
 $= 2.2 \text{ MHz (Min) - PNP}$
- Safe Operating Area — Rated to 60 V and 120 V, Respectively

*MAXIMUM RATINGS

Rating	Symbol	2N3055A MJ2955A	MJ15015 MJ15016	Unit
Collector-Emitter Voltage	V_{CEO}	60	120	Vdc
Collector-Base Voltage	V_{CBO}	100	200	Vdc
Collector-Emitter Voltage Base Reversed Biased	V_{CEV}	100	200	Vdc
Emitter-Base Voltage	V_{EBO}	7.0		Vdc
Collector Current — Continuous	I_C	15		Adc
Base Current	I_B	7.0		Adc
Total Device Dissipation @ $T_C = 25^\circ\text{C}$ Derate above 25°C	P_D	115 0.65	180 1.03	Watts W/ $^\circ\text{C}$
Operating and Storage Junction Temperature Range	T_J, T_{stg}	-65 to +200		$^\circ\text{C}$

THERMAL CHARACTERISTICS

Characteristic	Symbol	Max	Max	Unit
Thermal Resistance, Junction to Case	$R_{\theta JC}$	1.52	0.98	$^\circ\text{C/W}$

* Indicates JEDEC Registered Data. (2N3055A)

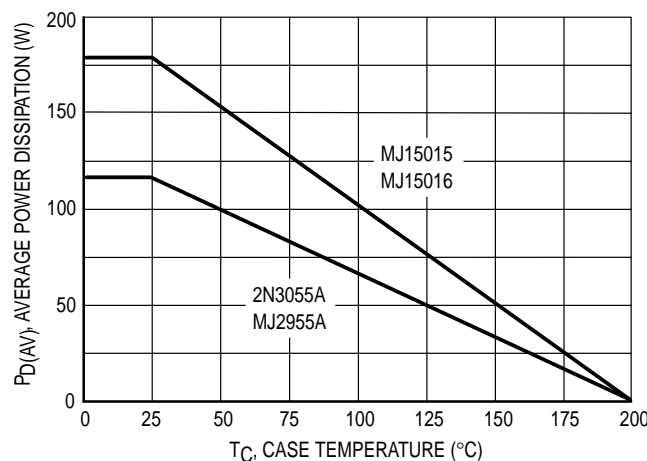

Figure 1. Power Derating

Preferred devices are Motorola recommended choices for future use and best overall value.

REV 1

© Motorola, Inc. 1995

NPN
2N3055A

MJ15015*

MJ2955A
PNP
MJ15016*

*Motorola Preferred Device

15 AMPERE
COMPLEMENTARY
SILICON
POWER TRANSISTORS
60, 120 VOLTS
115, 180 WATTS

CASE 1-07
TO-204AA
(TO-3)

2N3055A MJ15015 MJ2955A MJ15016

ELECTRICAL CHARACTERISTICS ($T_C = 25^\circ\text{C}$ unless otherwise noted)

Characteristic		Symbol	Min	Max	Unit
OFF CHARACTERISTICS (1)					
*Collector–Emitter Sustaining Voltage ($I_C = 200\text{ mAdc}$, $I_B = 0$)	2N3055A, MJ2955A MJ15015, MJ15016	$V_{CEO(sus)}$	60 120	— —	Vdc
Collector Cutoff Current ($V_{CE} = 30\text{ Vdc}$, $V_{BE(off)} = 0\text{ Vdc}$) ($V_{CE} = 60\text{ Vdc}$, $V_{BE(off)} = 0\text{ Vdc}$)	2N3055A, MJ2955A MJ15015, MJ15016	I_{CEO}	— —	0.7 0.1	mAdc
*Collector Cutoff Current ($V_{CEV} = \text{Rated Value}$, $V_{BE(off)} = 1.5\text{ Vdc}$)	2N3055A, MJ2955A MJ15015, MJ15016	I_{CEV}	— —	5.0 1.0	mAdc
Collector Cutoff Current ($V_{CEV} = \text{Rated Value}$, $V_{BE(off)} = 1.5\text{ Vdc}$, $T_C = 150^\circ\text{C}$)	2N3055A, MJ2955A MJ15015, MJ15016	I_{CEV}	— —	30 6.0	mAdc
Emitter Cutoff Current ($V_{EB} = 7.0\text{ Vdc}$, $I_C = 0$)	2N3055A, MJ2955A MJ15015, MJ15016	I_{EBO}	— —	5.0 0.2	mAdc

*SECOND BREAKDOWN

Second Breakdown Collector Current with Base Forward Biased ($t = 0.5\text{ s non-repetitive}$) ($V_{CE} = 60\text{ Vdc}$)	2N3055A, MJ2955A MJ15015, MJ15016	$I_{S/b}$	1.95 3.0	— —	Adc
--	--------------------------------------	-----------	-------------	--------	-----

*ON CHARACTERISTICS (1)

DC Current Gain ($I_C = 4.0\text{ Adc}$, $V_{CE} = 2.0\text{ Vdc}$) ($I_C = 4.0\text{ Adc}$, $V_{CE} = 4.0\text{ Vdc}$) ($I_C = 10\text{ Adc}$, $V_{CE} = 4.0\text{ Vdc}$)		h_{FE}	10 20 5.0	70 70 —	—
Collector–Emitter Saturation Voltage ($I_C = 4.0\text{ Adc}$, $I_B = 400\text{ mAdc}$) ($I_C = 10\text{ Adc}$, $I_B = 3.3\text{ Adc}$) ($I_C = 15\text{ Adc}$, $I_B = 7.0\text{ Adc}$)		$V_{CE(sat)}$	— — —	1.1 3.0 5.0	Vdc
Base–Emitter On Voltage ($I_C = 4.0\text{ Adc}$, $V_{CE} = 4.0\text{ Vdc}$)		$V_{BE(on)}$	0.7	1.8	Vdc

*DYNAMIC CHARACTERISTICS

Current–Gain — Bandwidth Product ($I_C = 1.0\text{ Adc}$, $V_{CE} = 4.0\text{ Vdc}$, $f = 1.0\text{ MHz}$)	2N3055A, MJ15015 MJ2955A, MJ15016	f_T	0.8 2.2	6.0 18	MHz
Output Capacitance ($V_{CB} = 10\text{ Vdc}$, $I_E = 0$, $f = 1.0\text{ MHz}$)		C_{ob}	60	600	pF

*SWITCHING CHARACTERISTICS (2N3055A only)

RESISTIVE LOAD					
Delay Time	$(V_{CC} = 30\text{ Vdc}$, $I_C = 4.0\text{ Adc}$, $I_{B1} = I_{B2} = 0.4\text{ Adc}$, $t_p = 25\text{ }\mu\text{s}$ Duty Cycle $\leq 2\%$)	t_d	—	0.5	μs
Rise Time		t_r	—	4.0	μs
Storage Time		t_s	—	3.0	μs
Fall Time		t_f	—	6.0	μs

(1) Pulse Test: Pulse Width = 300 μs , Duty Cycle $\leq 2\%$.

* Indicates JEDEC Registered Data. (2N3055A)

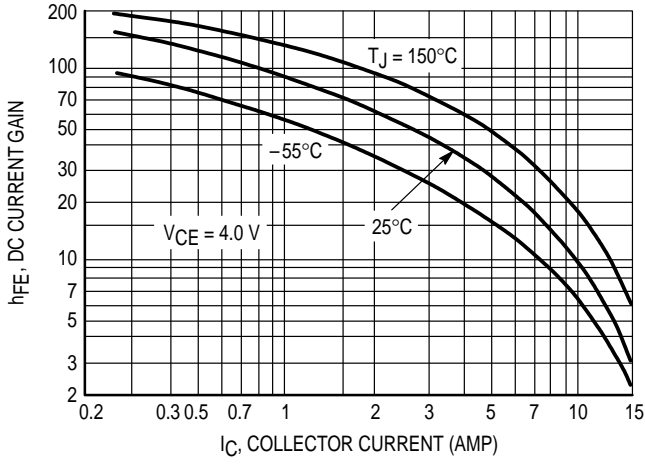

Figure 2. DC Current Gain

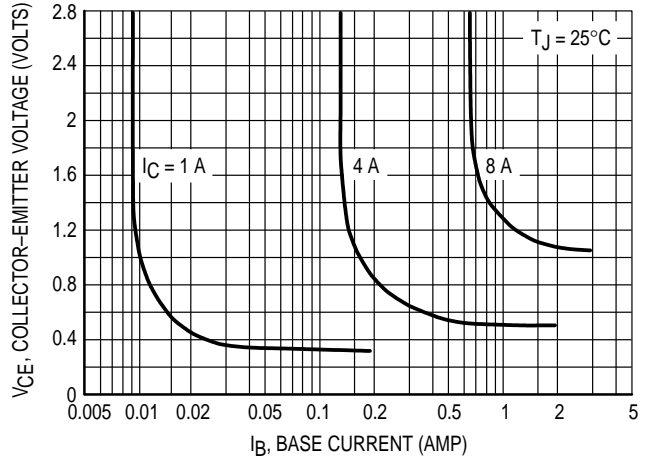

Figure 3. Collector Saturation Region

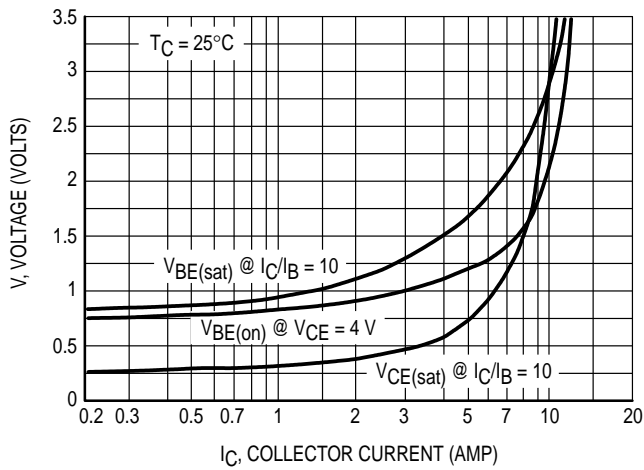

Figure 4. "On" Voltages

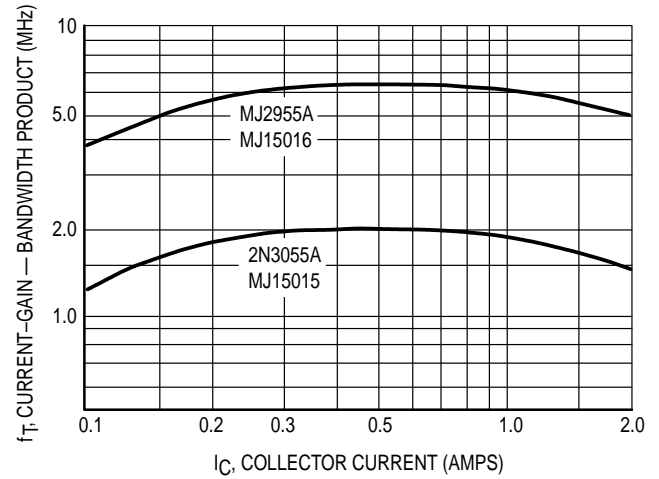

Figure 5. Current-Gain — Bandwidth Product

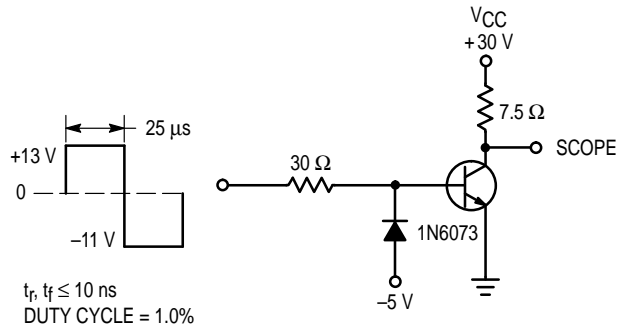

Figure 6. Switching Times Test Circuit
(Circuit shown is for NPN)

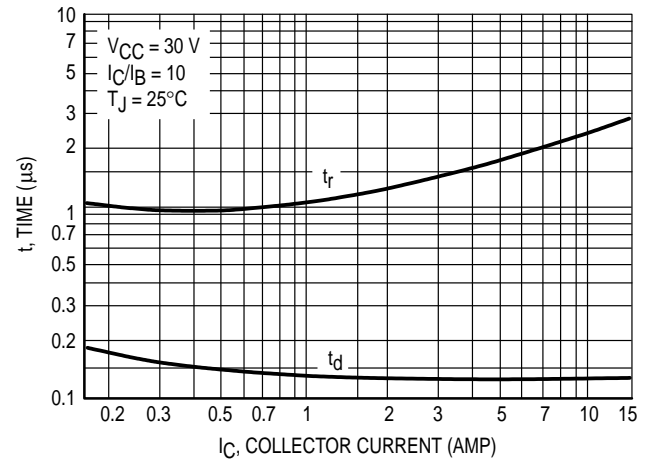

Figure 7. Turn-On Time

2N3055A MJ15015 MJ2955A MJ15016

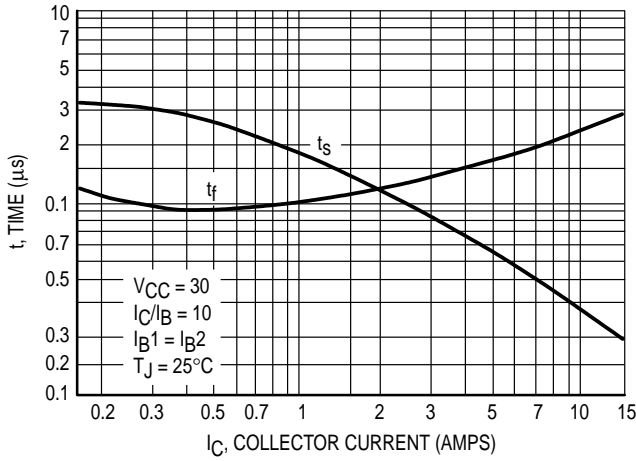

Figure 8. Turn-Off Times

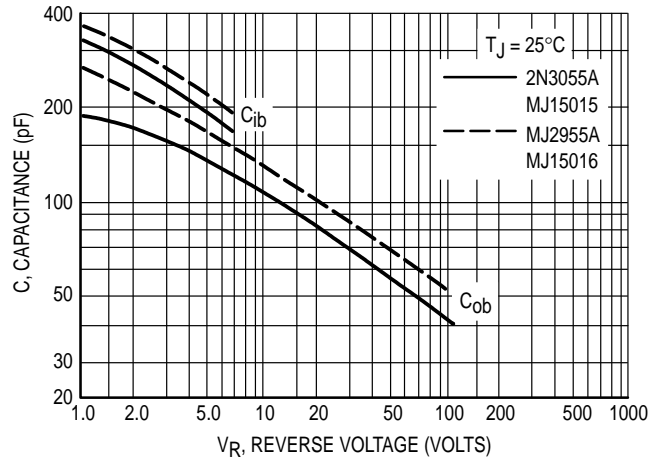

Figure 9. Capacitances

COLLECTOR CUT-OFF REGION

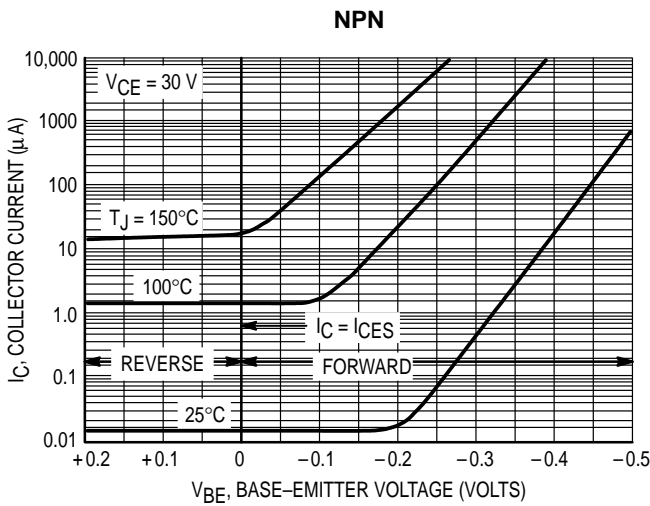

Figure 10. 2N3055A, MJ15015

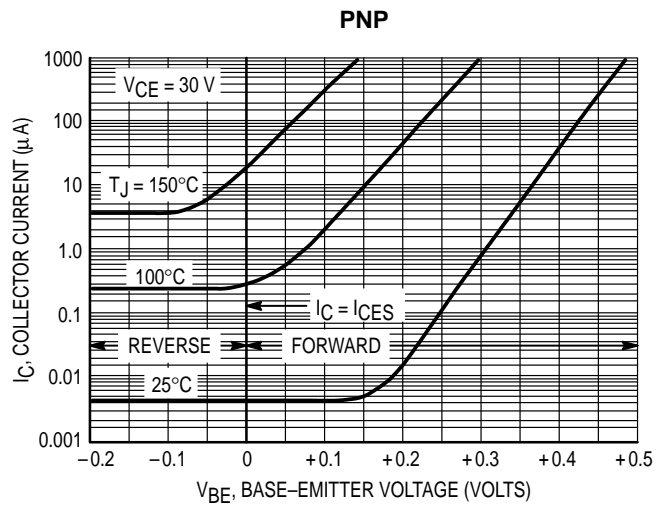
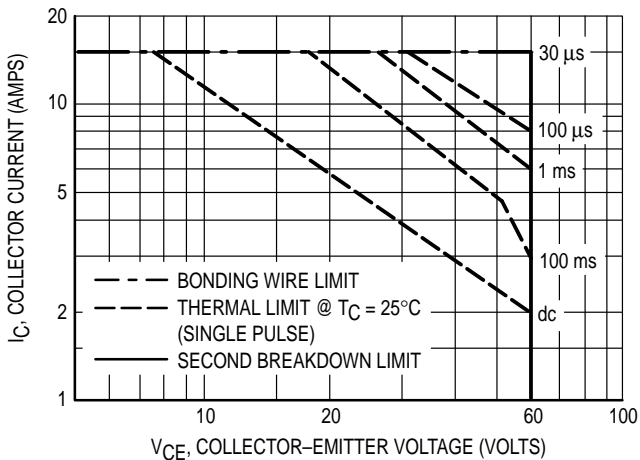
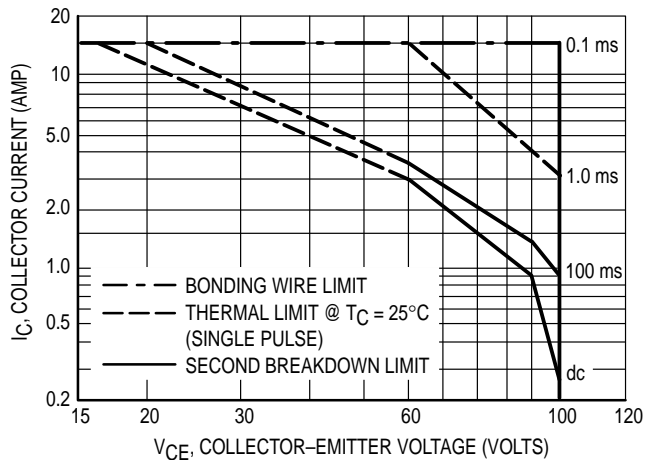

Figure 11. MJ2955A, MJ15016



**Figure 12. Forward Bias Safe Operating Area
2N3055A, MJ2955A**



**Figure 13. Forward Bias Safe Operating Area
MJ15015, MJ15016**

There are two limitations on the power handling ability of a transistor: average junction temperature and second breakdown. Safe Operating area curves indicate $I_C - V_{CE}$ limits of the transistor that must be observed for reliable operation; i.e., the transistor must not be subjected to greater dissipa-

tion than the curves indicate.

The data of Figures 12 and 13 is based on $T_C = 25^\circ\text{C}$; $T_{J(pk)}$ is variable depending on power level. Second breakdown pulse limits are valid for duty cycles to 10% but must be derated for temperature according to Figure 1.

PACKAGE DIMENSIONS

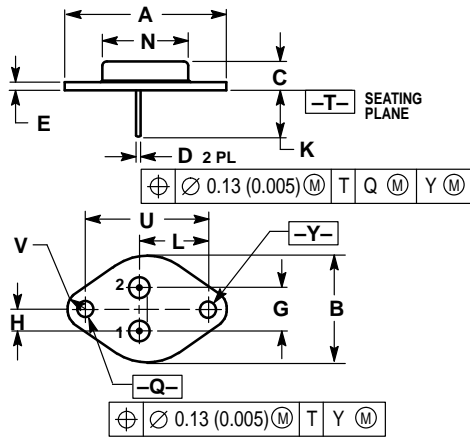

- NOTES:
1. DIMENSIONING AND TOLERANCING PER ANSI Y14.5M, 1982.
 2. CONTROLLING DIMENSION: INCH.
 3. ALL RULES AND NOTES ASSOCIATED WITH REFERENCED TO-204AA OUTLINE SHALL APPLY.

DIM	INCHES		MILLIMETERS	
	MIN	MAX	MIN	MAX
A	1.550 REF		39.37 REF	
B	—	1.050	—	26.67
C	0.250	0.335	6.35	8.51
D	0.038	0.043	0.97	1.09
E	0.055	0.070	1.40	1.77
G	0.430 BSC		10.92 BSC	
H	0.215 BSC		5.46 BSC	
K	0.440	0.480	11.18	12.19
L	0.665 BSC		16.89 BSC	
N	—	0.830	—	21.08
Q	0.151	0.165	3.84	4.19
U	1.187 BSC		30.15 BSC	
V	0.131	0.188	3.33	4.77

STYLE 1:
 PIN 1. BASE
 2. EMITTER
 CASE: COLLECTOR

CASE 1-07
 TO-204AA (TO-3)
 ISSUE Z

Motorola reserves the right to make changes without further notice to any products herein. Motorola makes no warranty, representation or guarantee regarding the suitability of its products for any particular purpose, nor does Motorola assume any liability arising out of the application or use of any product or circuit, and specifically disclaims any and all liability, including without limitation consequential or incidental damages. "Typical" parameters can and do vary in different applications. All operating parameters, including "Typicals" must be validated for each customer application by customer's technical experts. Motorola does not convey any license under its patent rights nor the rights of others. Motorola products are not designed, intended, or authorized for use as components in systems intended for surgical implant into the body, or other applications intended to support or sustain life, or for any other application in which the failure of the Motorola product could create a situation where personal injury or death may occur. Should Buyer purchase or use Motorola products for any such unintended or unauthorized application, Buyer shall indemnify and hold Motorola and its officers, employees, subsidiaries, affiliates, and distributors harmless against all claims, costs, damages, and expenses, and reasonable attorney fees arising out of, directly or indirectly, any claim of personal injury or death associated with such unintended or unauthorized use, even if such claim alleges that Motorola was negligent regarding the design or manufacture of the part. Motorola and  are registered trademarks of Motorola, Inc. Motorola, Inc. is an Equal Opportunity/Affirmative Action Employer.

How to reach us:

USA / EUROPE: Motorola Literature Distribution;
P.O. Box 20912; Phoenix, Arizona 85036. 1-800-441-2447

JAPAN: Nippon Motorola Ltd.; Tatsumi-SPD-JLDC, Toshikatsu Otsuki,
6F Seibu-Butsuryu-Center, 3-14-2 Tatsumi Koto-Ku, Tokyo 135, Japan. 03-3521-8315

MFAX: RMFAX0@email.sps.mot.com - TOUCHTONE (602) 244-6609
INTERNET: <http://Design-NET.com>

HONG KONG: Motorola Semiconductors H.K. Ltd.; 8B Tai Ping Industrial Park,
51 Ting Kok Road, Tai Po, N.T., Hong Kong. 852-26629298

