

Package Outline

* = Similar Package

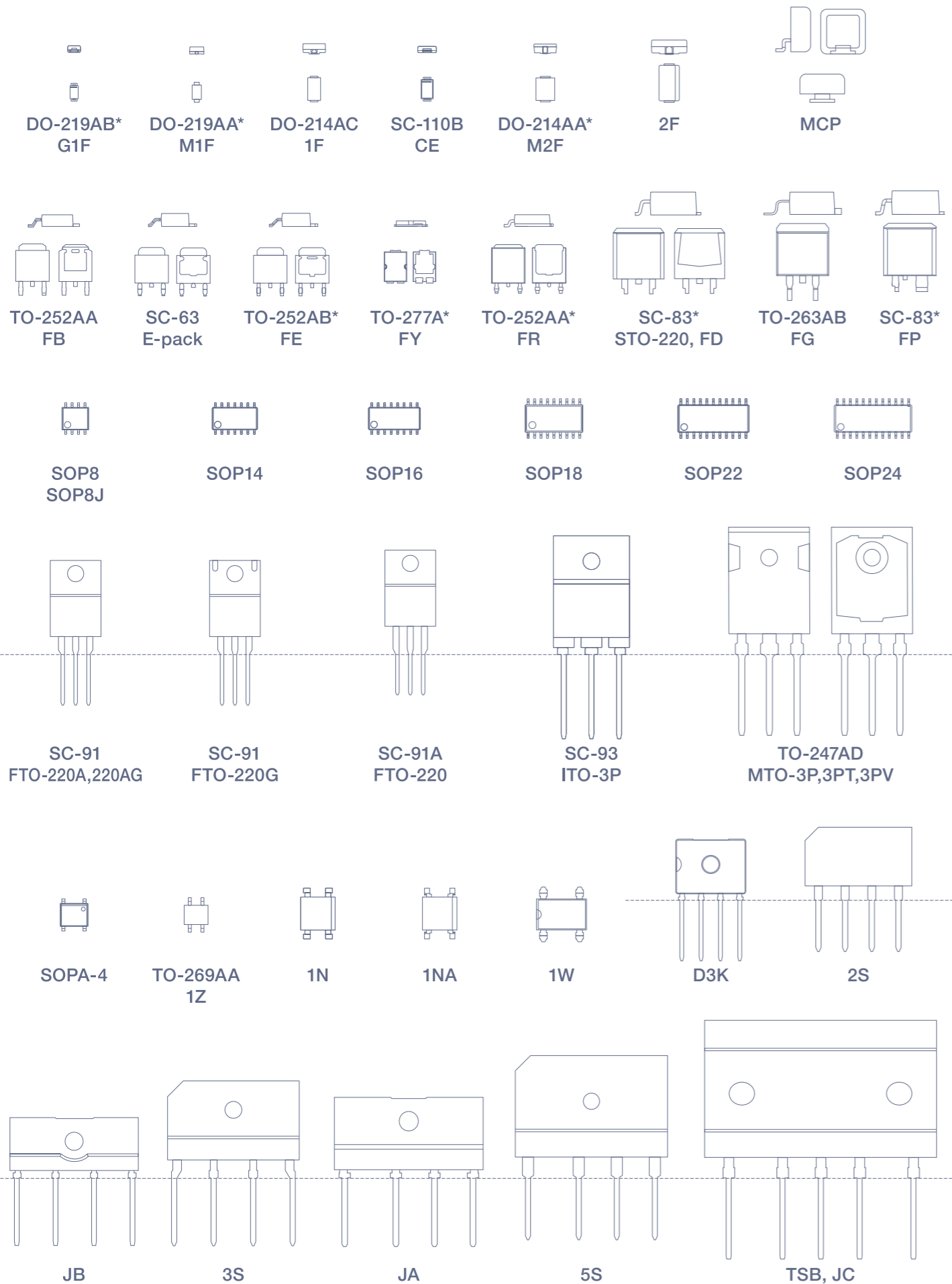

Semiconductor Product Catalog

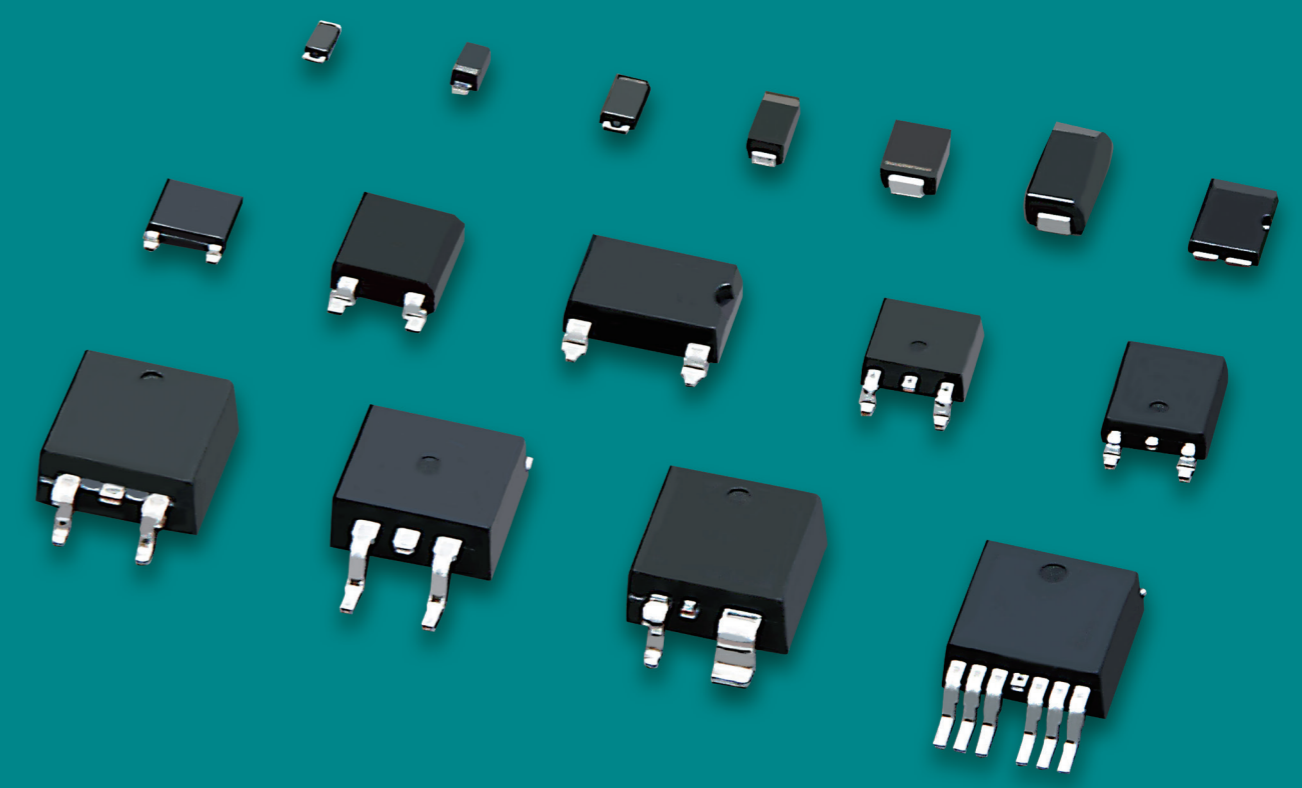

Shindengen Electric Manufacturing Co., Ltd.

www.shindengen.co.jp

CAT.NO.F072-14a

2103-000(1)

ShinDengen

New power. Your power.

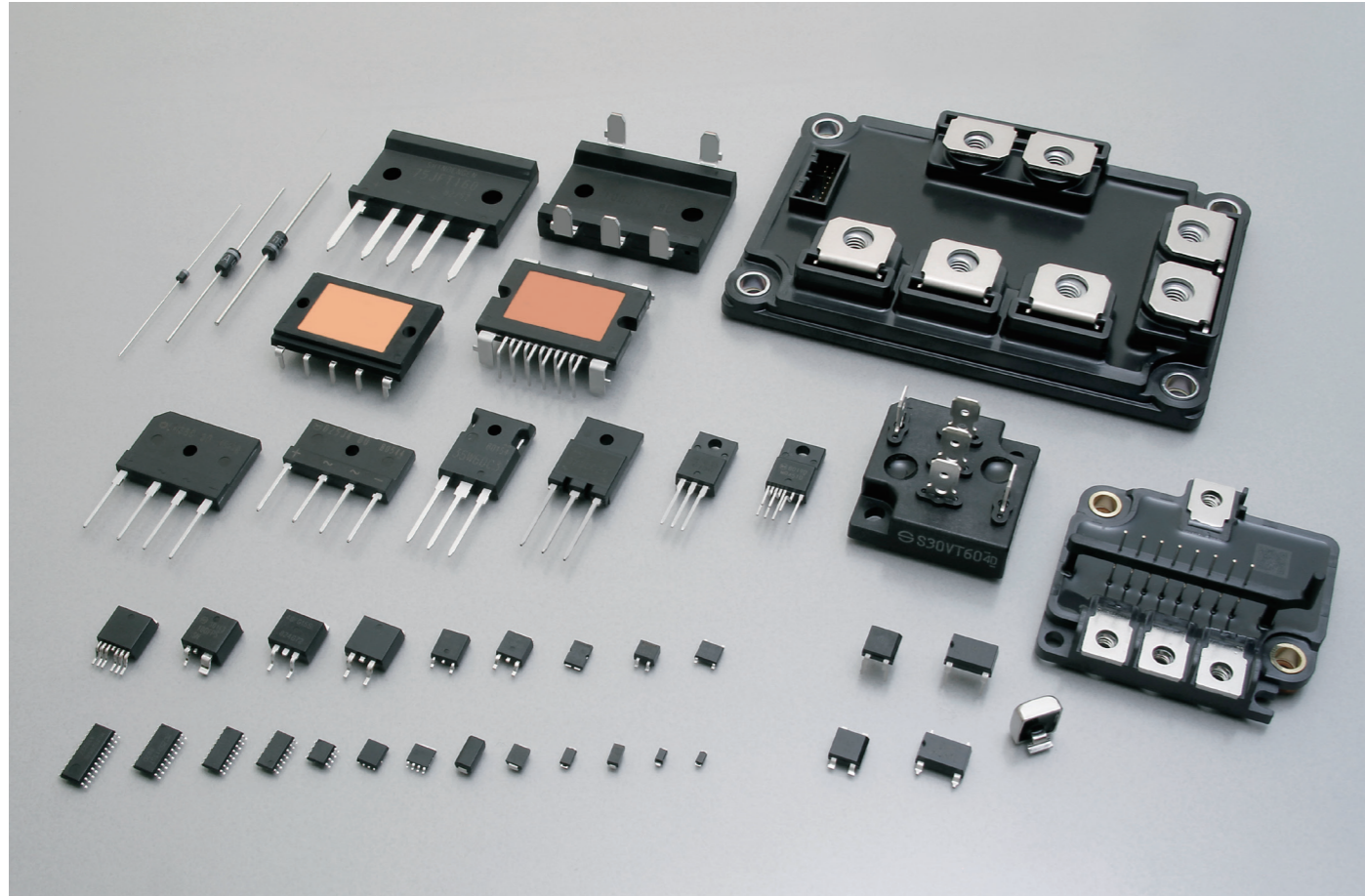

Notes

- ⚠ If you wish to use any such product, please be sure to refer to the specifications issued by Shindengen.
- ⚠ All products described or contained herein are designed with a quality level intended for use in standard applications requiring an ordinary level of reliability. If these products are to be used in equipment or devices for special or specific applications requiring an extremely high grade of quality or reliability in which failures or malfunctions of products may directly affect human life or health, a local Shindengen office must be contacted in advance to confirm that the intended use of the product is appropriate. Shindengen products are grouped into the following three applications according to the quality grade.
 - Standard applications
Computers, office automation and other office equipment, communication terminals, test and measurement equipment, audio/visual equipment, amusement equipment, consumer electronics, machine tools, personal electronic equipment, industrial equipment, etc.
 - Special applications
Transportation equipment (vehicles, ships, etc.), trunk-line communication equipment, traffic signal control systems, anti-disaster/crime systems, safety equipment, medical equipment, etc.
 - Specific applications
Nuclear reactor control systems, aircraft, aerospace equipment, submarine repeaters, life support equipment and systems, etc.
- ⚠ Although Shindengen continuously endeavors to enhance the quality and reliability of its products, customers are advised to consider and take safety measures in their design, such as redundancy, fire containment and anti-failure, so that personal injury, fires, or societal damages can be prevented.
- ⚠ Please note that all information described or contained herein is subject to change without notice due to product upgrades and other reasons. When buying Shindengen products, please contact the Company's offices or distributors to obtain the latest information.
- ⚠ Shindengen shall not bear any responsibility with regards to damages or infringement of any third-party patent rights and other intellectual property rights incurred due to the use of information on this website.
- ⚠ The information and materials on this website neither warrant the use of Shindengen's or any third party's patent rights and other intellectual property rights, nor grant license to such rights.
- ⚠ In the event that any product described or contained herein falls under the category of strategic products controlled under the Foreign Exchange and Foreign Trade Control Law of Japan, exporting of such products shall require an export license from the Japanese government in accordance with the above law.
- ⚠ No reprinting or reproduction of the materials on this website, either in whole or in part, is permitted without proper authorization from Shindengen.

SALES OFFICES

U.S.A.

Shindengen America, Inc. www.shindengen.com/

1540E, Dundee Road Suite 350 Palatine IL.60074. U.S.A.
Phone:+1-847-444-1363 FAX:+1-847-444-0654

Europe

Shindengen UK Ltd. www.shindengen.co.uk/

Head Office

Unit 1, 1 Tapper Walk, King's Cross, London, N1C 4AQ U.K.
Phone:+44-20-3829-6980 FAX:+44-20-3725-6855

German Branch

Prinzenallee 1, 40549 Düsseldorf, Germany
Phone:+49-211-5206-590 FAX:+49-211-4986-499

Asia

Shindengen Singapore PTE Ltd.

750D, Chai Chee Road, #05-01, ESR BizPark
@ Chai Chee, Singapore 469004.
Phone:+65-6445-0082 FAX:+65-6445-6089

Shindengen (H.K.) Co., Ltd.

Head Office

Suite 2006B, 20/F., Exchange Tower, 33 Wang Chiu Road,
Kowloon Bay, HK
Phone:+852-2317-1884 FAX:+852-2314-8561

Taiwan Representative Office

3F-1., No.126, Songjiang Road, Zhongshan District,
Taipei City 10457, Taiwan, R.O.C.
Phone:+886-2-2100-1218 FAX:+886-2-2100-2018

Shindengen (SHANGHAI) Electric Co., Ltd.

Room1506, Sheng GaoInt'l Building, 137 Xian Xia Road,
Chang Ning, Shanghai, China
Phone:+86-21-6270-8000 FAX:+86-21-6270-0419

Shindengen Electric Mfg. Co., Ltd.

Seoul Office

B701-4, 230, Simin-daero, Dongan-gu, Anyang-si,
Gyeonggi-do, 14067 Korea
Phone:+82-31-385-1431 FAX:+82-31-385-1430

Japan

Shindengen Electric MFG. Co., Ltd. www.shindengen.co.jp/

Head Office

New-Ohtemachi Bldg., 2-2-1, Ohtemachi, Chiyoda-ku,
Tokyo 100-0004, Japan
Phone:+81-3-3279-4431 FAX:+81-3-3279-6478

Asaka Office

3-14-1, Saiwai-cho, Asaka City,
Saitama 351-8503, Japan
Phone:+81-48-483-5311 FAX:+81-48-483-4117

Osaka Branch Office

Minami Senba Heart Bldg., 2-3-2, Minami-Senba,
Chuo-ku, Osaka City, Osaka 542-0081, Japan
Phone:+81-6-6264-7770 FAX:+81-6-6260-1222

Nagoya Branch Office

Nagoya Daiichi Bldg., 1-19-24, Nishiki, Naka-ku,
Nagoya City, Aichi 460-0003, Japan
Phone:+81-52-221-1361 FAX:+81-52-201-4780

Hamamatsu branch

Hamamatsu Daiichi Seimei Nittsu Bldg., 110-5, Itaya-cho,
Naka-ku, Hamamatsu City, Shizuoka 430-0928, Japan
Phone:+81-53-450-3800 FAX:+81-53-450-3801

Utsunomiya Sales Office

Flora Bldg., 1-9-15 Higashi Syukugou Utsunomiya City,
Tochigi 321-0953, Japan
Phone:+81-28-637-3615 FAX:+81-28-637-3115

- All specifications are subject to change without notice.
- Please consult us for the latest specifications before you order.
- Please use this products after reading manual well.

• Printed April 2021

This catalog includes the products which might be subject to the foreign exchange and foreign trade laws.

P3-6	INDEX
P7-10	GENERAL RECTIFYING DIODES
P11-20	BRIDGE DIODES
P21-30	SCHOTTKY BARRIER DIODES
P31-36	FAST RECOVERY DIODES
P37-38	THYRISTORS
P39-40	SIDACs
P41-42	TRIACs
P43-44	SURGE ABSORBERS
P45-48	TVS (Transient Surge Suppressor)
P49-54	POWER MOSFETs
P55-56	POWER MODULES
P57-60	POWER ICs
P61-82	PACKAGE LIST • OUTLINE DIMENSIONS
P83-84	PACKING SPECIFICATION
P85	NOTES •How to Order •Outline of Packing Form •About AEC-Q101 & Automotive Grade

INDEX

Type No.	Page	Type No.	Page	Type No.	Page	Type No.	Page	Type No.	Page	Type No.	Page	Type No.	Page	Type No.	Page
D1F60	8	D2SBA60	14	D8FD60LUS	32	D25JAB80V	14	DF5VD60	10	G1V(A)20C	40	KP40RU22	44	MCZ5216ST	60
D1F60A	8	D3CE4S	22	D8JBB60V	14	D25XB60	14	DF8L60US	32	G1V(B)20C	40	KU4F8	44	MCZ5601SC	60
D1FE60	8	D3CE6S	22	D8JBB80V	14	D25XB80	14	DF10L60	32	G1V(B)22C	40	KU4F12	44	MCZ5606SC	60
D1FH3	22	D3CE15ST	22	D10FDC10ST	26	D25XB100	14	DF10LC20U	34	G1V(B)24C	40	KU5S31NS	44	MCZ5607SC	60
D1FJ4	22	D3CE20LUS	32	D10FR60LA	32	D30FD60K	32	DF10LC30	34	G1VL8C	40	KU10L08	44	MF2003SV	60
D1FJ8	22	D3CE60K	32	D10FR60V	8	D30FDC4S	26	DF10NC15	26	G1VL10C	40	KU10N14	44	MF2007SW	60
D1FJ8A	22	D3CE60V	8	D10FY4R5ST	22	D30FDC10ST	26	DF10SC4M	26	G1VL15C	40	KU10NU11	44	MG001AK028060A	56
D1FJ10	22	D3CE60VE	8	D10FY4R5SY	22	D30FDC15ST	26	DF10SC6	26	G1VL20C	40	KU10NU13	44	MG001AL030060A	56
D1FK60	32	D3F60	8	D10FY6ST	22	D30JCB100K	18	DF10SC9	26	G1VL22C	40	KU10R23NS	44	MG031B090004A	56
D1FK70	32	D3FE60	8	D10FY6SY	22	D30JCT120V	16	DF15JC10	26	G1VL24C	40	KU10R27NS	44	MG031E120004A	56
D1FK100	32	D3FJ10	22	D10FY10ST	22	D30VC60	10	DF15NC15	26	K1V10	40	KU10R29NS	44	MG031G148004A	56
D1FK120	32	D3FK60	32	D10FY10SY	22	D30XBN20	18	DF15SC4M	26	K1V11	40	KU10S31NS	44	MG031L080006A	56
D1FK120P	32	D3FK120	32	D10FY15ST	22	D30XT80	16	DF15VD60	10	K1V12	40	KU10S35NS	44	MG031MC148004A	56
D1FL20U	32	D3FS4A	22	D10FY60VE	8	D35XB80	14	DF16VC60R	10	K1V14	40	KU15N14	44	MG031MD110006A	56
D1FL40U	32	D3FS6	22	D10JBB60V	14	D40FDC10ST	26	DF20JC10	26	K1V22	40	LK25XB60	20	MG031N110006A	56
D1FM3	22	D3S4M	24	D10JBB80V	14	D40FDC15ST	26	DF20L60	32	K1V22(W)	40	LL15XB60	20	MG032A4207R5A	56
D1FS4	22	D3S6M	24	D10SBS4	18	D45JCT120V	16	DF20L60U	32	K1V24	40	LL25XB60	20	MG032B420010A	56
D1FS4A	22	D3SB60	14	D10XB60	14	D45JCT160V	16	DF20LC20US	34	K1V24(W)	40	LN1F60	8	MG038A200080A	18
D1FS6	22	D3SB80	14	D10XB60H	14	D45XT80	16	DF20LC30	34	K1V26	40	LN1WBA60	20	MG038B150080A	18
D1FS6A	22	D3SBA60	14	D10XB80	14	D45XT160	16	DF20NC15	26	K1V26(W)	40	LN4SB60	20	MG038C200160A	18
D1FT4	22	D4F60	8	D15FR4ST	22	D50JCB80V	14	DF20SC4M	26	K1V36(W)	40	LN6SB60	20	MG038D150160A	18
D1FT4A	22	D4SB60L	14	D15FR60LA	32	D50XB80	14	DF20SC9M	26	K1V38(W)	40	LN15XB60	20	MG048A150004A	56
D1FT6	22	D4SB80	14	D15FR60V	8	D70JHB80V	14	DF25SC6M	26	K1V(A)10	40	LN15XB60H	20	MG048B100006A	56
D1FT6A	22	D4SBL20U	18	D15FY4R5ST	22	D75JFT80V	16	DF25V60	8	K1V(A)11	40	LN25XB60	20	MG060C100080A	18
D1FT10	22	D4SBN20	18	D15FY4R5SY	22	D100JHT80V	16	DF30JC4	26	K1V(A)12	40	M1F60	8	MG061A150080A	18
D1FT10A	22	D4SBS4	18	D15FY6ST	22	D100JHT120V	16	DF30JC6	26	K1V(A)16	40	M1F80	8	MG061B200080A	18
D1FT15A	22	D4SBS6	18	D15FY6SY	22	D100JHT160V	16	DF30JC10	26	K1VZL09	40	M1FE40	8	MH2501SC	60
D1N60	8	D5CE4S	22	D15FY10ST	22	D120SC4M	30	DF30NC15	26	K1VZL20	40	M1FE60	8	MH2511SC	60
D1N80	8	D5FE60	8	D15FY10SY	22	D120SC6M	30	DF30SC3ML	26	KC3FB40H	38	M1FH3	22	MS1003SH	60
D1NF60	32	D5FY4R5ST	22	D15FY15ST	22	D180SC4M	30	DF30SC4M	26	KC5FB40H	38	M1FJ4	22	MS1004SH	60
D1NK60	32	D5FY4R5SY	22	D15JAB60V	14	D180SC6M	30	DF40SC3L	26	KC5FB60H	38	M1FK60	32	MS1005SK	60
D1NK100	32	D5FY6ST	22	D15JAB80V	14	D240SC4M	30	DF40SC4	26	KC5FB60HR	38	M1FL20U	32	MS1006SK	60
D1NL20U	32	D5FY6SY	22	D15XB60	14	D240SC6M	30	DG1H3	22	KC5FB60HRT	38	M1FL40U	32	MS1007SH	60
D1NL40U	32	D5FY10ST	22	D15XB60H	14	D360SC4M	30	DG1H3A	22	KC5SF60HRT	38	M1FM3	22	MV1001SC	58
D1NS4	24	D5FY10SY	22	D15XB80	14	D360SC6M	30	DG1J10A	22	KC8SF80	38	M1FS4	22	MV1002SC	58
D1NS6	24	D5FY15ST	22	D15XB100	14	DE3L20UA	32	DG1M3	22	KD3FB60	42	M1FS6	22	MV1011SC	58
D1UBA80	12	D5FY20SN	22	D15XBN20	18	DE3S4M	22	DG1M3A	22	KD3SF60	42	M2F60	8	MV1012SC	58
D2F60	8	D5FY60K	32	D15XBS6	18	DE3S6M	22	DG1N15A	22	KD3SF60E	42	M2FH3	22	MV2002SG	58
D2FK60	32	D5SB60	14	D20FD60LU	32	DE5L60A	32	DG1S4	22	KD5SF60	42	M2FL20U	32	MV2052SG	58
D2FL20U	32	D5SB80	14	D20FDC10ST	26	DE5L60U	32	DG1S6	22	KD8SF60	42	M2FM3	22	POR5B60HP2	54
D2FL40	32	D5SBA60	14	D20FDC15ST	26	DE5LC20U	34	DG1S6A	22	KD12SF60	42	M3F60	8	P1B52HP2	54
D2FL40U	32	D6FEC4ST	26	D20FDC20L	34	DE5S4M	22	DL04-18F1	46	KD16SF60	42	M3FE40	8	P1FE90VX3	54
D2FS4	22	D6FEC10ST	26	D20FDC20LUS	34	DE5S6M	22	DL04-33F1	46	KD20SF60	42	M3FE60	8	P1R5B40HP2	54
D2FS6	22	D6FEC12ST	26	D20FR4ST	22	DE5SC3ML	26	DL04-36F1	46	KL3L07	44	M3FL20U	32	P2B60HP2F	54
D2L20U	32	D6FEC15ST	26	D20FR4R5S	22	DE5SC4M	26	G1V(A)8C	40	KL3N14	44	MCZ5203SE	60	P2R5B52HP2F	54
D2L40U	32	D6JBB60V	14	D20XB60	14	DE5SC6M	26	G1V(A)10C	40	KL3R20	44	MCZ5205SE	60	P3B28HP2	54
D2S4M	24	D6JBB80V	14	D20XB80	14	DE5VE40	8	G1V(A)12C	40	KL3Z07	44	MCZ5207SG	60	P3F60HP2	54
D2S6M	24	D6SB60L	14	D20XBS6	18	DE10S3L	22	G1V(A)13C	40	KL3Z18	44	MCZ5208SG	60	P3FH90VX3	54
D2SB60	14	D6SB80	14	D25FD60V	8	DE10SC3L	26	G1V(A)14C	40	KP20NU11	44	MCZ5209SN	60	P4B40HP2	54
D2SB60A	14	D6SBN20	18	D25JAB60V	14	DE10SC4	26	G1V(A)15C	40	KP40NU11	44	MCZ5211ST	60	P4B60HP2F	54

INDEX















Type No.	Page	Type No.	Page	Type No.	Page	Type No.	Page	Type No.	Page	Type No.	Page	Type No.	Page	Type No.	Page
P4F60HP2	54	P24LF4QNK	50	P60B4EL	50	P153FP6SNK	52	S15VT80	18	SF5L60U	34	SG40TC12M	28	ST04-33F1	46
P4F90VX3	54	P25B6EB	50	P60B4SN	50	P168FP7R5SN	52	S15VTA60	18	SF5LC40UM	36	ST02-12G1	46	ST04-36F1	46
P5B52HP2	54	P25LA12SL	50	P60B6EL	50	P168FP7R5SNK	52	S15VTA80	18	SF8K60M	34	ST02-14G1	46	ST04-39F1	46
P5F50HP2	54	P25LF12SL	50	P60B6EN	50	P175FP4SN	52	S15WB60	16	SF8K60USM	34	ST02-16G1	46	ST06-18CE	46
P5F50HP2F	54	P25LF12SLK	50	P60B6SN	50	P175FP4SNK	52	S20K60T	34	SF10K60M	34	ST02-18G1	46	ST06-27CE	46
P5F60HP2	54	P25LF12SN	50	P64LF6QL	50	P180FP4SN	52	S20K100V	34	SF10KC60M	36	ST02-20G1	46	ST06-30CE	46
P5FH90VX3	54	P25LF12SNK	50	P64LF6QLK	50	P180FP4SNK	52	S20LC20UST	36	SF10L60AM	34	ST02-24G1	46	ST06-33CE	46
P6B28HP2	54	P26B10SL	50	P64LF6QNK	50	P180FP6SN	52	S20LC30T	36	SF10L60U	34	ST02-27G1	46	ST06-36CE	46
P6B40HP2	54	P26B10SN	50	P64LF6QNK	50	P180FP6SNK	52	S20LC40UT	36	SF10L60MSM	34	ST02-30G1	46	ST06-39CE	46
P6B52HP2	54	P26F28HP2	54	P66F7R5SN	52	P211FZ4QMKA	52	S20LC40UV	36	SF10L60MVM	34	ST02-33G1	46	ST20-27F2	46
P6F50HP2	54	P26FE10SLK	52	P66F7R5SNK	52	P240FZ4QLA	52	S20LC60UST	36	SF10LC40UM	36	ST02-36G1	46	ST20-30F2	46
P7F60HP2	54	P30B10EL	50	P70F5EN	52	P240FZ4QNKA	52	S20LC60USV	36	SF20K60M	34	ST02-39G1	46	ST20-33F2	46
P7F90VX3	54	P30FE4SLK	52	P70F7R5EN	52	S1NAD80	10	S20SC9MT	28	SF20KC60M	36	ST02-43G1	46	ST20-36F2	46
P8B10SB	50	P30FE6SLK	52	P70FP12SN	52	S1NB60	12	S20VT60	18	SF20L60AM	34	ST02-47G1	46	ST20-47F2	46
P8B28HP2	54	P30FE7R5SLK	52	P70FP12SNK	52	S1NB80	12	S20VT80	18	SF20L60U	34	ST02-58G1	46	ST60-40MF	46
P8B30HP2	54	P30LA10SL	50	P70LF4QLK	50	S1NBB80	12	S20VTA60	18	SF20L60MSM	34	ST02-75F1	46	ST60-48MF	46
P8F28HP2	54	P30W60HP2V	54	P70LF4QNK	50	S1NBC60	12	S20VTA80	18	SF20L60MVM	34	ST02-82F1	46	ST70-27F	46
P8F50HP2	54	P32B12SN	50	P72LF7R5SL	50	S1NBC80	12	S20WB60	16	SF20LC30M	36	ST02-100F1	46	ST70-27FZ	46
P8FE10SBK	52	P32F12SN	52	P72LF7R5SLK	50	S1WB(A)60	12	S20WB80	16	SG5L20USM	34	ST02-120F1	46	ST70-27MF	46
P9B30HP2F	54	P32FG15SL	52	P72LF7R5SN	50	S1WB(A)60B	12	S25VB60	16	SG5LC20USM	36	ST02-140F1	46	ST70-30MF	46
P9B40HP2	54	P32LF10SL	50	P72LF7R5SNK	50	S1WB(A)80	12	S25VB80	16	SG5S4M	24	ST02-170F1	46	ST80-14MF	46
P10B28HP2	54	P32LF10SLK	50	P80FG6EAL	52	S1ZAS4	30	S30K60T	34	SG5S6M	24	ST02-200F1	46	UD2KB80	14
P10F50HP2	54	P32LF10SN	50	P80FG7R5EN	52	S1ZB60	12	S30K60V	34	SG5S9M	24	ST02-280F1	46	UD3KB80	14
P10F60HP2	54	P32LF10SNK	50	P80FH5ENK	52	S1ZB80	12	S30K100V	34	SG8SC4M	28	ST02-320F1	46	UD4KB80	14
P12F60HP2	54	P34F6EL	52	P82F7R5SN	52	S2K100	32	S30SC4MT	28	SG10L20USM	34	ST02D-82	48	UD6KBA80	14
P12FE7R5SBK	52	P36F28HP2	54	P85FG6EAL	52	S2L20U	32	S30SC6MT	28	SG10LC20USM	36	ST02D-140	48	UD8KBA80	14
P13F28HP2	54	P38LF6QLK	50	P86F6SN	52	S2L40U	32	S30TC15T	28	SG10SC3LM	28	ST02D-140F2	48	VR61F1	44
P13F50HP2	54	P38LF6QNK	50	P88FP10SN	52	S2L60	32	S30V60T	10	SG10SC4M	28	ST02D-170	48		
P14FE6SBK	52	P40B10SL	50	P88FP10SNK	52	S2V60	8	S30V80V	10	SG10SC6M	28	ST02D-170F2	48		
P15F50HP2	54	P40B10SN	50	P90FG5R5SL	52	S2V80	8	S30VT60	18	SG10SC9M	28	ST02D-200	48		
P15F60HP2	54	P40B6SL	50	P94FG5R5SL	52	S2VB60	16	S30VT80	18	SG10TC15M	28	ST02DH-280	48		
P15F60HP2F	54	P40F10SN	52	P98LF6QL	50	S2WB(A)80	12	S30VT160	18	SG15SC4M	28	ST02DH-320	48		
P15LA12SL	50	P40F12SN	52	P98LF6QLK	50	S3K60	32	S30VTA60	18	SG15SC6M	28	ST03-43F1	46		
P16B6SB	50	P40LF12SL	50	P98LF6QNK	50	S3L20U	32	S30VTA80	18	SG20JC6M	28	ST03-47F1	46		
P17F28HP2	54	P40LF12SLK	50	P98LF6QNK	50	S3L40U	32	S30VTA160	18	SG20LC20USM	36	ST03-58F1	46		
P18LA12SL	50	P40LF12SN	50	P100FA7R5EN	52	S3L60	32	S40HC1R5T	28	SG20SC3LM	28	ST03-68F1	46		
P18LF6QLK	50	P40LF12SNK	50	P100FH4ENK	52	S3V60	8	S40T15V	24	SG20SC4M	28	ST03-240F1	46		
P18LF6QNK	50	P42F6EN	52	P100FP12SN	52	S3V80	8	S50VB60	16	SG20SC6M	28	ST03D-82	48		
P19LA10SL	50	P46LF7R5SL	50	P100FP12SNK	52	S3V100D	8	S50VB80	16	SG20SC9M	28	ST03D-140	48		
P20B12SL	50	P46LF7R5SLK	50	P105LF4QL	50	S3WB60	16	S60HC1R5T	28	SG20TC10M	28	ST03D-170	48		
P20B12SN	50	P46LF7R5SN	50	P105LF4QLK	50	S4VB60	16	S60HC3T	28	SG20TC12M	28	ST03D-200	48		
P20F50HP2	54	P46LF7R5SNK	50	P105LF4QN	50	S5VB60	16	S60JC10V	28	SG20TC15M	28	ST03DH-240	48		
P20FE12SLK	52	P50F10SN	52	P105LF4QNK	50	S10VB60	16	S60SC3LT	28	SG30JC6M	28	ST04-12F1	46		
P21F28HP2	54	P50LF10SL	50	P126FP10SN	52	S10VT60	18	S60SC4MT	28	SG30SC3LM	28	ST04-14F1	46		
P22F10SN	52	P50LF10SLK	50	P126FP10SNK	52	S10VT80	18	S60SC6MT	28	SG30SC4M	28	ST04-16F1	46		
P22FE4SBK	52	P50LF10SN	50	P140LF4QL	50	S10VTA60	18	S90T15V	24	SG30SC6M	28	ST04-18F1	46		
P23F40HP2FM	54	P50LF10SNK	50	P140LF4QLK	50	S10VTA80	18	SF3K60M	34	SG30TC10M	28	ST04-20F1	46		
P23LA10SL	50	P54B4SN	50	P140LF4QN	50	S10WB60	16	SF3L60U	34	SG30TC12M	28	ST04-24F1	46		
P24B4SB	50	P55F6EN	52	P140LF4QNK	50	S15VB60	16	SF5K60M	34	SG30TC15M	28	ST04-27F1	46		
P24LF4QLK	50	P56LA4SN	50	P153FP6SN	52	S15VT60	18	SF5L40UM	34	SG40TC10M	28	ST04-30F1	46		



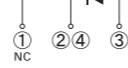

GENERAL RECTIFYING DIODES

General Rectifying Diodes are defined as high-voltage and PN junction type devices.

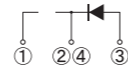
These devices utilize our original glass passivation which is physically stable with a superior structure for resistance against heat and humidity. Variations are available for breakdown voltage up to 800V and output current from 1 to 30A.

Single

Surface Mount							
Package	JEDEC Code JEITA Code House Name	Fig.	IF (AV) [A]	VRRM [V]			Remarks
				400	600	800	
 3.9 × 1.8 × 1.4(mm)	DO-219AA similar M1F	B2	1		M1F60 M1FE60	M1F80	
			2	M1FE40			
 5.0 × 2.5 × 2.0(mm)	DO-214AC 1F	B3-1	1		D1F60 D1FE60		
			1.1		LN1F60		
			1.2		D1F60A		
 4.7 × 2.4 × 0.98(mm)	SC-110B CE	B5-1	3		D3CE60V		
			3.5		D3CE60VE		
 5.1 × 3.75 × 2.0(mm)	DO-214AA similar M2F	B6	1.2		M2F60		
			3	M3FE40	M3F60 M3FE60		
 7.6 × 4.0 × 2.8(mm)	SC-63 E-pack 2F	B9-1	1.4		D2F60		
			3		D3F60 D3FE60		
			4		D4F60		
			5		D5FE60		
 9.5 × 6.6 × 2.65(mm)	SC-63 E-pack	G1-5	5	DE5VE40			
 6.5 × 4.5 × 1.1(mm)	TO-277A similar FY	G4	10		D10FY60VE		
 9.6 × 6.6 × 2.3(mm)	TO-252AA similar FR	G5	10		D10FR60V		
			15		D15FR60V		
 13.2 × 10.2 × 4.7(mm)	SC-83 similar STO-220	H1-2	25		DF25V60		
 13.2 × 10.2 × 4.6(mm)	SC-83 similar FD	H2-1	25		D25FD60V		

Axial							
Package	JEDEC Code JEITA Code House Name	Fig.	IF (AV) [A]	VRRM [V]			Remarks
				400	600	800	
 3.0 × φ 2.6(mm)	AX057	A1	1		D1N60	D1N80	
 7.0 × φ 4.4(mm)	AX10	A5-1	1.7		S2V60	S2V80	
 7.0 × φ 4.4(mm)	AX14	A7	3			S3V100D	
			3.5		S3V60	S3V80	

Single

Surface Mount														
Package		Type No.	Absolute Maximum Ratings					Electrical Characteristics				Halogen free	Based on AEC-Q101	Automotive
JEDEC Code JEITA Code House Name	Fig.		VRRM [V]	IF (AV) [A]	Conditions Ta [°C]	IFSM [A]	Tj [°C]	Vf (max) [V]	Conditions IF [A]	Ir (max) Vr=VRRM [μA]	VESD (typ) [kV]			
DO-219AA similar M1F	B2	M1F60	600	1	25	25	150	1.10	1	10	—	—	—	○
		M1FE60	600	1	129 *1	30	150	1.10	1	10	25	—	○	○
		M1F80	800	1	25	25	150	1.10	1	10	—	—	—	○
		M1FE40	400	2	103 *2	25	150	1.10	1	10	—	—	—	○
DO-214AC 1F	B3-1	D1F60	600	1	25	25	150	1.10	1	10	—	—	—	○
		D1FE60	600	1	126 *1	30	150	1.10	1	10	25	—	○	○
		LN1F60 *3	600	1.1	25	25	150	1.05	0.8	10	—	—	—	○
		D1F60A	600	1.2	25	45	150	0.97	1.2	10	—	—	—	○
SC-110B CE	B5-1	D3CE60V	600	3	101 *1	50	150	1.10	3	10	—	—	—	○
		D3CE60VE	600	3.5	93 *1	60	-55 to 150	1.10	3.5	10	25	—	○	■
DO-214AA similar M2F	B6	M2F60	600	1.2	51	50	150	0.97	1.2	10	—	—	—	○
		M3FE40	400	3	76 *1	75	150	1.10	3	10	30	—	○	○
		M3F60	600	3	100 *1	90	150	1.05	3	10	—	—	—	○
		M3FE60	600	3	76 *1	90	150	1.05	3	10	25	—	○	○
2F	B9-1	D2F60	600	1.4	25	60	150	1.05	1.4	10	—	—	—	○
		D3F60	600	3	80 *1	150	150	1.05	3	10	—	—	—	○
		D3FE60	600	3	105 *1	150	150	1.05	3	10	25	—	○	○
		D4F60	600	4	68 *1	200	150	0.95	4	10	—	—	—	○
		D5FE60	600	5	82 *1	300	150	0.95	5	10	25	—	○	○
SC-63 E-pack	G1-5	DE5VE40	400	5	130 *2	80	150	1.00	5	10	30	—	—	■
TO-277A similar FY	G4	D10FY60VE	600	10	120 *1	220	-55 to 150	1.10	10	10	25	○	○	○
TO-252AA similar FR	G5	D10FR60V	600	10	130 *2	200	-55 to 150	1.05	10	10	—	—	—	■
		D15FR60V	600	15	125 *2	300	-55 to 150	1.05	15	10	—	—	—	■
SC-83 similar STO-220	H1-2	DF25V60	600	25	136 *2	400	150	1.10	25	10	—	—	—	—
SC-83 similar FD	H2-1	D25FD60V	600	25	113 *2	450	150	1.10	25	10	—	—	○	○

*1 : Tl *2 : Tc *3 : trr(max)=3.5μs ■ : Please contact us.

Axial														
Package		Type No.	Absolute Maximum Ratings					Electrical Characteristics				Halogen free	Based on AEC-Q101	Automotive
JEDEC Code JEITA Code House Name	Fig.		VRRM [V]	IF (AV) [A]	Conditions Ta [°C]	IFSM [A]	Tj [°C]	Vf (max) [V]	Conditions IF [A]	Ir (max) Vr=VRRM [μA]	VESD (typ) [kV]			
AX057	A1	D1N60	600	1	25	30	150	1.05	1	10	—	—	—	—
		D1N80	800	1	25	30	150	1.05	1	10	—	—	—	—
AX10	A5-1	S2V60	600	1.7	40	60	150	1.05	1.7	10	—	—	—	—
		S2V80	800	1.7	40	60	150	1.05	1.7	10	—	—	—	—
AX14	A7	S3V100D	800	3	130 *1	150	150	1.05	3	10 *2	—	—	—	—
		S3V60	600	3.5	40	120	150	1.05	2.6	10	—	—	—	—
		S3V80	800	3.5	40	120	150	1.05	2.6	10	—	—	—	—

*1 : Tl *2 : Vr=1000V

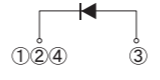

GENERAL RECTIFYING DIODES

Single

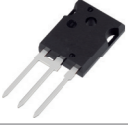
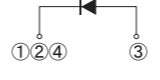
Two Terminal Type							
Package	JEDEC Code JEITA Code House Name	Fig.	I _{F(AV)} [A]	V _{RRM} [V]			Remarks
				400	600	800	
 41.0 × 16.0 × 5.0(mm)	TO-247AD — MTO-3PT	K2	30		S30V60T		

Three Terminal Type							
Package	JEDEC Code JEITA Code House Name	Fig.	I _{F(AV)} [A]	V _{RRM} [V]			Remarks
				400	600	800	
 41.0 × 16.0 × 5.0(mm)	TO-247AD — MTO-3PV	K6	30		S30V80V		

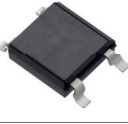
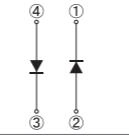
Array

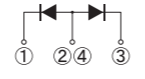
Surface Mount							
Package	JEDEC Code JEITA Code House Name	Fig.	I _{F(AV)} [A]	V _{RRM} [V]			Remarks
				400	600	800	
 10.0 × 6.8 × 2.6(mm)	— — 1NA	C6-2	3		S1NAD80		
 13.2 × 10.2 × 4.7(mm)	— SC-83 similar STO-220	H1-5	5		DF5VD60		
			15		DF15VD60		
		H1-7	16		DF16VC60R		

Diode Module

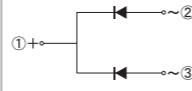
Diode Module							
Package	JEDEC Code JEITA Code House Name	Fig.	I _{F(AV)} [A]	V _{RRM} [V]			Remarks
				400	600	800	
 22.3 × 22.3 × 25.0(mm)	— — D30VC	E2	30		D30VC60		

Single

Two Terminal Type														
Package		Type No.	Absolute Maximum Ratings					Electrical Characteristics				Halogen free	Based on AEC-Q101	Automotive
JEDEC Code JEITA Code House Name	Fig.		V _{RRM} [V]	I _{F(AV)} [A]	Conditions T _C [°C]	I _{FSM} [A]	T _J [°C]	V _F (max) [V]	Conditions I _F [A]	I _R (max) V _R =V _{RRM} [μA]	V _{ESD} (typ) [kV]			
TO-247AD — MTO-3PT	K2	S30V60T	600	30	119	360	150	1.1	30	10	—	—	—	—

Three Terminal Type														
Package		Type No.	Absolute Maximum Ratings					Electrical Characteristics				Halogen free	Based on AEC-Q101	Automotive
JEDEC Code JEITA Code House Name	Fig.		V _{RRM} [V]	I _{F(AV)} [A]	Conditions T _C [°C]	I _{FSM} [A]	T _J [°C]	V _F (max) [V]	Conditions I _F [A]	I _R (max) V _R =V _{RRM} [μA]	V _{ESD} (typ) [kV]			
TO-247AD — MTO-3PV	K6	S30V80V	800	30	131	450	150	1.1	30	10	—	—	—	○

Array

Surface Mount														
Package		Type No.	Absolute Maximum Ratings					Electrical Characteristics				Halogen free	Based on AEC-Q101	Automotive
JEDEC Code JEITA Code House Name	Fig.		V _{RRM} [V]	I _{F(AV)} [A]	Conditions T _C [°C]	I _{FSM} [A]	T _J [°C]	V _F (max) [V]	Conditions I _F [A]	I _R (max) V _R =V _{RRM} [μA]	V _{ESD} (typ) [kV]			
— — 1NA	C6-2	S1NAD80	800	3	102 *	110	150	1.05	0.75	10	—	—	—	—
— SC-83 similar STO-220	H1-5	DF5VD60	600	5	140	140	150	1.05	2.50	10	—	—	—	—
		DF15VD60	600	15	127	190	150	1.05	7.50	10	—	—	—	—
	H1-7	DF16VC60R	600	16	124	190	150	1.05	8.00	10	—	—	—	—

* : T_L

Diode Module





Diode Module														
Package		Type No.	Absolute Maximum Ratings					Electrical Characteristics				Halogen free	Based on AEC-Q101	Automotive
JEDEC Code JEITA Code House Name	Fig.		V _{RRM} [V]	I _{F(AV)} [A]	Conditions T _C [°C]	I _{FSM} [A]	T _J [°C]	V _F (max) [V]	Conditions I _F [A]	I _R (max) V _R =V _{RRM} [μA]	V _{ESD} (typ) [kV]			
— — D30VC	E2	D30VC60	600	30	124	300	150	1.05	15	10	—	—	—	—



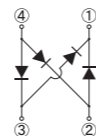

BRIDGE DIODES

Bridge Diodes are suitable for the rectification of commercial voltage.

Variations are available for various packaging as well as high voltage (Max 1600V), high IFSM, low V_F, and low noise.

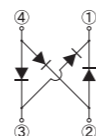
Small Bridge Diodes

Surface Mount							
Package	JEDEC Code JEITA Code House Name	Fig.	I _{F(AV)} [A]	V _{RRM} [V]			Remarks
				600	800	1000	
 7.0 × 4.7 × 2.6(mm)	TO-269AA 1Z	C2-1	0.8	S1ZB60	S1ZB80		
 6.2 × 5.15 × 1.45(mm)	SOPA-4	C1	1		D1UBA80		
 10.0 × 6.8 × 2.6(mm)	1N	C4	1	S1NB60	S1NB80		
 10.0 × 6.8 × 2.6(mm)	1NA	C6-1	1.5	S1NBC60	S1NBC80		
 10.6 × 10.2 × 3.1(mm)	1W	C8	1	S1WB(A)60 S1WB(A)60B	S1WB(A)80		
			2	S2WB(A)80			

THD (Through Hole Device)							
Package	JEDEC Code JEITA Code House Name	Fig.	I _{F(AV)} [A]	V _{RRM} [V]			Remarks
				600	800	1000	
 3.8 × 4.7 × 2.5(mm)	1Z	C3	0.8	S1ZB60	S1ZB80		
 6.5 × 6.8 × 2.5(mm)	1N	C5	1	S1NB60	S1NB80		
 6.5 × 6.8 × 2.5(mm)	1NA	C7	1.5	S1NBC60	S1NBC80		
 6.2 × 10.2 × 3.0(mm)	1W	C9	1	S1WB(A)60 S1WB(A)60B	S1WB(A)80		
			2	S2WB(A)80			

Small Bridge Diodes

Surface Mount														
Package		Type No.	Spec. Code	Absolute Maximum Ratings					Electrical Characteristics			Halogen free	UL	Automotive
JEDEC Code JEITA Code House Name	Fig.			V _{RRM} [V]	I _{F(AV)} [A]	Conditions T _a [°C]	I _{FSM} [A]	T _J [°C]	V _F (max) [V]	Conditions I _F [A]	I _R (max) V _R =V _{RRM} [μA]			
TO-269AA	C2-1	S1ZB60	-7072	600	0.8	25	30	150	1.05	0.4	10	-	-	-
1Z		S1ZB80	-7072	800	0.8	25	30	150	1.05	0.4	10	-	-	-
SOPA-4	C1	D1UBA80	-7062	800	1	25	30	150	0.95	0.4	10	-	-	-
1N	C4	S1NB60	-7062	600	1	25	30	150	1.05	0.5	10	-	-	-
		S1NB80	-7062	800	1	25	30	150	1.05	0.5	10	-	-	-
1NA	C6-1	S1NBB80	-7062	800	1	26	50	150	1.05	0.5	10	-	-	-
		S1NBC60	-7062	600	1.5	105 *	60	150	1.05	0.75	10	-	-	-
		S1NBC80	-7062	800	1.5	105 *	60	150	1.05	0.75	10	-	-	-
1W	C8	S1WB(A)60	-7062	600	1	25	30	150	1.00	0.5	10	-	-	-
		S1WB(A)60B	-7062	600	1	25	50	150	1.00	0.5	10	-	-	-
		S1WB(A)80	-7062	800	1	25	30	150	1.00	0.5	10	-	-	-
		S2WB(A)80	-7062	800	2	112 *	50	-40 to 150	1.05	1	10	-	-	-











* : Tl

THD (Through Hole Device)														
Package		Type No.	Spec. Code	Absolute Maximum Ratings					Electrical Characteristics			Halogen free	UL	Automotive
JEDEC Code JEITA Code House Name	Fig.			V _{RRM} [V]	I _{F(AV)} [A]	Conditions T _a [°C]	I _{FSM} [A]	T _J [°C]	V _F (max) [V]	Conditions I _F [A]	I _R (max) V _R =V _{RRM} [μA]			
1Z	C3	S1ZB60	-7101	600	0.8	25	30	150	1.05	0.4	10	-	-	-
		S1ZB80	-7101	800	0.8	25	30	150	1.05	0.4	10	-	-	-
1N	C5	S1NB60	-7101	600	1	25	30	150	1.05	0.5	10	-	-	-
		S1NB80	-7101	800	1	25	30	150	1.05	0.5	10	-	-	-
1NA	C7	S1NBB80	-7101	800	1	26	50	150	1.05	0.5	10	-	-	-
		S1NBC60	-7101	600	1.5	105 *	60	150	1.05	0.75	10	-	-	-
		S1NBC80	-7101	800	1.5	105 *	60	150	1.05	0.75	10	-	-	-
1W	C9	S1WB(A)60	-7101	600	1	25	30	150	1.00	0.5	10	-	-	-
		S1WB(A)60B	-7101	600	1	25	50	150	1.00	0.5	10	-	-	-
		S1WB(A)80	-7101	800	1	25	30	150	1.00	0.5	10	-	-	-
		S2WB(A)80	-7101	800	2	112 *	50	-40 to 150	1.05	1	10	-	-	-

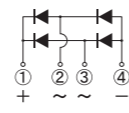
* : Tl

BRIDGE DIODES

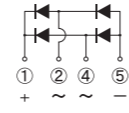
SIP (Single In-line Package) Bridge Diodes

THD (Through Hole Device)							
Package	JEDEC Code JEITA Code House Name	Fig.	I _{F(AV)} [A]	V _{RRM} [V]			Remarks
				600	800	1000	
 24.0 × 13.8 × 3.1(mm)	— — D3K	D1	2		UD2KB80		
			3		UD3KB80		
			4		UD4KB80		
			6		UD6KBA80		
			8		UD8KBA80		
 24.5 × 20.0 × 3.5(mm)	— — 2S	D2	1.5	D2SBA60 D2SB60			
			2	D2SB60A			
 25.2 × 25.0 × 4.2(mm)	— — JB	D5	6	D6JBB60V	D6JBB80V		
			8	D8JBB60V	D8JBB80V		
			10	D10JBB60V	D10JBB80V		
 32.5 × 25.0 × 4.6(mm)	— — 3S	D3	4	D3SBA60 D3SB60 D4SB60L	D3SB80 D4SB80		
			10	D10XB60 D10XB60H	D10XB80		
 29.4 × 29.0 × 4.6(mm)	— — JA	D6	15	D15JAB60V	D15JAB80V		
			25	D25JAB60V	D25JAB80V		
 37.5 × 30.0 × 4.6(mm)	— — 5S	D4	6	D5SBA60 D5SB60 D6SB60L	D5SB80 D6SB80		
			15	D15XB60 D15XB60H	D15XB80	D15XB100	
			20	D20XB60	D20XB80		
			25	D25XB60	D25XB80	D25XB100	
 47.0 × 45.7 × 7.5(mm)	— — TSB(4pin)	D7	50		D50XB80		
			50		D50JCB80V		
 47.0 × 45.7 × 7.5(mm)	— — JC(4pin)	D7	50		D50JCB80V		
			50		D50JCB80V		

■ : New product

DIP (Dual In-line Package) Bridge Diode

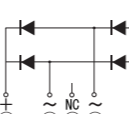
Package	JEDEC Code JEITA Code House Name	Fig.	I _{F(AV)} [A]	V _{RRM} [V]			Remarks
				600	800	1000	
 47.0 × 45.7 × 7.5(mm)	— — JH	D10-1	70		D70JHB80V		

SIP (Single In-line Package) Bridge Diodes

THD (Through Hole Device)													
Package		Type No.	Absolute Maximum Ratings					Electrical Characteristics			Halogen free	UL	Automotive
JEDEC Code JEITA Code House Name	Fig.		V _{RRM} [V]	I _{F(AV)} [A]	Conditions T _C [°C]	I _{FSM} [A]	T _J [°C]	V _F (max) [V]	Conditions I _F [A]	I _R (max) V _R =V _{RRM} [μA]			
— — D3K	D1	UD2KB80	800	2	143	62	150	1.05	1	10	—	UL	—
		UD3KB80	800	3	140	90	150	1.05	1.5	10	—	UL	—
		UD4KB80	800	4	138	135	150	1.00	2	10	—	UL	—
		UD6KBA80	800	6	131	135	150	1.05	3	10	—	UL	—
		UD8KBA80	800	8	126	165	150	1.05	4	10	—	UL	—
— — 2S	D2	D2SBA60	600	1.5	25 *1	60	150	1.05	0.75	10	—	—	—
		D2SB60	600	1.5	25 *1	80	150	1.05	0.75	10	—	—	—
		D2SB60A	600	2	115 *2	120	150	0.95	1	10	—	—	—
— — JB	D5	D6JBB60V	600	6	131	100	150	1.05	3	10	—	UL	—
		D6JBB80V	800	6	131	100	150	1.05	3	10	—	UL	—
		D8JBB60V	600	8	130	130	150	1.05	4	10	—	UL	—
		D8JBB80V	800	8	130	130	150	1.05	4	10	—	UL	—
		D10JBB60V	600	10	129	150	150	1.05	5	10	—	UL	—
— — 3S	D3	D3SBA60	600	4	108	80	150	1.05	2	10	—	UL	—
		D3SB60	600	4	108	120	150	1.05	2	10	—	UL	—
		D4SB60L	600	4	111	150	150	0.95	2	10	—	UL	—
		D3SB80	800	4	108	120	150	1.05	2	10	—	UL	—
		D4SB80	800	4	108	150	150	0.95	2	10	—	UL	—
		D10XB60	600	10	100	120	150	1.10	5	10	—	UL	—
		D10XB60H	600	10	112	170	150	1.05	5	10	—	UL	—
		D10XB80	800	10	100	120	150	1.10	5	10	—	UL	—
		D15JAB60V	600	15	110	200	150	1.05	7.5	10	—	UL	—
		D15JAB80V	800	15	110	200	150	1.05	7.5	10	—	UL	—
— — JA	D6	D25JAB60V	600	25	107	350	150	1.05	12.5	10	—	UL	—
		D25JAB80V	800	25	107	350	150	1.05	12.5	10	—	UL	—
		D5SBA60	600	6	111	120	150	1.05	3	10	—	UL	—
		D5SB60	600	6	110	170	150	1.05	3	10	—	UL	—
		D6SB60L	600	6	112	170	150	1.05	3	10	—	UL	—
		D5SB80	800	6	110	170	150	1.05	3	10	—	UL	—
		D6SB80	800	6	110	170	150	1.05	3	10	—	UL	—
		D15XB60	600	15	100	200	150	1.10	7.5	10	—	UL	—
		D15XB60H	600	15	107	240	150	1.05	7.5	10	—	UL	—
		D15XB80	800	15	100	200	150	1.10	7.5	10	—	UL	—
		D15XB100	1000	15	110	200	150	1.10	7.5	10	—	UL	—
		D20XB60	600	20	87	240	150	1.10	10	10	—	UL	—
		D20XB80	800	20	87	240	150	1.10	10	10	—	UL	—
		D25XB60	600	25	98	350	150	1.05	12.5	10	—	UL	■
		D25XB80	800	25	98	350	150	1.05	12.5	10	—	UL	■
		D25XB100	1000	25	106	350	150	1.05	12.5	10	—	UL	—
■ D35XB80	800	35	93	603 *3	-55 to 150	1.05	17.5	10	—	UL	—		
— — TSB(4pin)	D7	D50XB80	800	50	95	600	150	1.05	25	10	—	UL	—
		D50JCB80V	800	50	94	600	150	1.05	25	10	—	UL	■







■ : New product *1 : T_a *2 : T_l *3 : 60Hz ■ : Please contact us. UL : UL recognized (UL File No. E142422)

DIP (Dual In-line Package) Bridge Diode

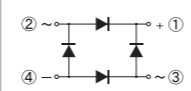



THD (Through Hole Device)													
Package		Type No.	Absolute Maximum Ratings					Electrical Characteristics			Halogen free	UL	Automotive
JEDEC Code JEITA Code House Name	Fig.		V _{RRM} [V]	I _{F(AV)} [A]	Conditions T _C [°C]	I _{FSM} [A]	T _J [°C]	V _F (max) [V]	Conditions I _F [A]	I _R (max) V _R =V _{RRM} [μA]			
— — JH	D10-1	D70JHB80V	800	70	99	500	-55 to 150	1.1	35	10	—	—	—

BRIDGE DIODES



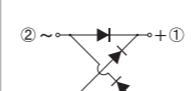

SQIP (Square In-line Package) Bridge Diodes

Package	JEDEC Code JEITA Code House Name	Fig.	I _{F(AV)} [A]	V _{RRM} [V]			Remarks
				600	800	1000	
 13.0 × 13.0 × 27.5(mm)	— S2VB	E3	2	S2VB60			
 17.0 × 17.0 × 32.5(mm)	— S4VB	E4	4	S4VB60			
 25.0 × 25.0 × 32.5(mm)	— S5VB	E5	6	S5VB60			
 22.0 × 22.0 × 32.5(mm)	— S10VB	E6	10	S10VB60			
 26.5 × 26.5 × 25.0(mm)	— S15VB	E7	15	S15VB60			
 32.0 × 32.0 × 25.0(mm)	— S25VB	E8	25	S25VB60	S25VB80		
 36.0 × 36.0 × 24.0(mm)	— S50VB	E9	50	S50VB60	S50VB80		

Input/Output In-line Terminal Type

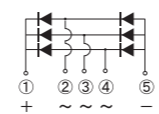
Package	JEDEC Code JEITA Code House Name	Fig.	I _{F(AV)} [A]	V _{RRM} [V]			Remarks
				600	800	1000	
 17.0 × 17.0 × 31.0(mm)	— S3WB	E10	2.3	S3WB60			
 22.5 × 22.5 × 32.5(mm)	— S10WB	E11	10	S10WB60			
 26.5 × 26.5 × 32.5(mm)	— S15WB	E12	15	S15WB60			
 32.5 × 32.5 × 32.5(mm)	— S20WB	E13	20	S20WB60	S20WB80		

3 Phase Bridge Diodes

Package	JEDEC Code JEITA Code House Name	Fig.	I _{F(AV)} [A]	V _{RRM} [V]			Remarks
				800	1200	1600	
 47.0 × 45.7 × 7.5(mm)	— TSB(5pin)	D8	30	D30XT80			
			45	D45XT80		D45XT160	
 47.0 × 45.7 × 7.5(mm)	— JC(5pin)	30		D30JCT120V			
		45		D45JCT120V	D45JCT160V		
 47.0 × 45.7 × 7.5(mm)	— JF	D9	75	D75JFT80V			
 47.0 × 45.7 × 7.5(mm)	— JH	D10-2	100	D100JHT80V	D100JHT120V	 D100JHT160V	

 : New product

SQIP (Square In-line Package) Bridge Diodes

Package		Type No.	Absolute Maximum Ratings					Electrical Characteristics			Halogen free	UL	Automotive
JEDEC Code JEITA Code House Name	Fig.		V _{RRM} [V]	I _{F(AV)} [A]	Conditions T _C [°C]	I _{FSM} [A]	T _J [°C]	V _F (max) [V]	Conditions I _F [A]	I _R (max) V _R =V _{RRM} [μA]			
— S2VB	E3	S2VB60	600	2 *1	40	40	150	1.05	1	10	—	—	—
— S4VB	E4	S4VB60	600	4	40	80	150	1.05	2	10	—	—	—
— S5VB	E5	S5VB60	600	6	40	200	150	1.05	3	10	—	—	—
— S10VB	E6	S10VB60	600	10	40	200	150	1.05	5	10	—	—	—
— S15VB	E7	S15VB60	600	15	83 *2	200	150	1.05	7.5	10	—	—	—
— S25VB	E8	S25VB60	600	25	85 *2	400	150	1.05	12.5	10	—	—	—
—		S25VB80	800	25	85 *2	400	150	1.05	12.5	10	—	—	—
— S50VB	E9	S50VB60	600	50	95 *2	500	150	1.05	25	10	—	—	—
—		S50VB80	800	50	95 *2	500	150	1.05	25	10	—	—	—











*1 : Without heatsink *2 : T_C  : UL recognized (UL File No. E142422)

Input/Output In-line Terminal Type

Package		Type No.	Absolute Maximum Ratings					Electrical Characteristics			Halogen free	UL	Automotive
JEDEC Code JEITA Code House Name	Fig.		V _{RRM} [V]	I _{F(AV)} [A]	Conditions T _C [°C]	I _{FSM} [A]	T _J [°C]	V _F (max) [V]	Conditions I _F [A]	I _R (max) V _R =V _{RRM} [μA]			
— S3WB	E10	S3WB60	600	2.3	40 *	120	150	1.05	2	10	—	—	—
— S10WB	E11	S10WB60	600	10	74	170	150	1.05	5	10	—	—	—
— S15WB	E12	S15WB60	600	15	77	200	150	1.05	7.5	10	—	—	—
— S20WB	E13	S20WB60	600	20	76	500	150	1.05	10	10	—	—	—
—		S20WB80	800	20	76	500	150	1.05	10	10	—	—	—

* : T_a  : UL recognized (UL File No. E142422)

3 Phase Bridge Diodes



Package		Type No.	Absolute Maximum Ratings					Electrical Characteristics			Halogen free	UL	Automotive
JEDEC Code JEITA Code House Name	Fig.		V _{RRM} [V]	I _{F(AV)} [A]	Conditions T _C [°C]	I _{FSM} [A]	T _J [°C]	V _F (max) [V]	Conditions I _F [A]	I _R (max) V _R =V _{RRM} [μA]			
— TSB(5pin)	D8	D30XT80	800	30	117	300	150	1.05	10	10	—		—
		D45XT80	800	45	101	400	150	1.05	15	10	—		—
		D45XT160	1600	45	97	360 *	150	1.05	15	100	—		—
— JC(5pin)		D30JCT120V	1200	30	116	300	150	1.05	10	10	—		—
		D45JCT120V	1200	45	99	450	150	1.05	15	10	—		—
	D45JCT160V	1600	45	97	450	150	1.05	15	10	—		—	
— JF	D9	D75JFT80V	800	75	109	400	150	1.05	25	10	—	—	—
— JH	D10-2	D100JHT80V	800	100	99	500	-55 to 150	1.10	35	10	—		—
		D100JHT120V	1200	100	92	450	-55 to 150	1.17	35	10	—		—
		 D100JHT160V	1600	100	92	540	-55 to 150	1.15	35	10	—		—

 : New product * : 60Hz  : UL recognized (UL File No. E142422)

BRIDGE DIODES

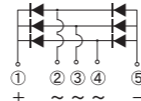

Series	Feature
S	Evenly balanced Vf and Ir
N	Low Vf, High Voltage
K	Low Vf

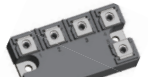
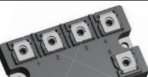
3 Phase Bridge Diodes

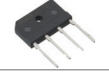
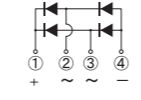

Package	JEDEC Code JEITA Code House Name	Fig.	IF (AV) [A]	VRRM [V]			Remarks
				600	800	1600	
 36.0 × 36.0 × 24.0(mm)	— — SVT	E15	10	S10VT60	S10VT80		
			15	S15VT60	S15VT80		
			20	S20VT60	S20VT80		
			30	S30VT60	S30VT80	S30VT160	
 36.0 × 36.0 × 23.0(mm)	— — SVTA	E14	10	S10VTA60	S10VTA80		
			15	S15VTA60	S15VTA80		
			20	S20VTA60	S20VTA80		
			30	S30VTA60	S30VTA80	S30VTA160	
 89.0 × 50.0 × 16.6(mm)	— — MG038	F7	150		MG038B150080A	★ MG038D150160A	
			200		MG038A200080A	★ MG038C200160A	
 84.5 × 46.0 × 17.0(mm)	— — MG060	F9	100		★ MG060C100080A		
 91.0 × 52.0 × 17.0(mm)	— — MG061	F10	150		★ MG061A150080A		
			200		★ MG061B200080A		

■ : New product ★ : Under development

High Speed Bridge Diodes (SBD)

THD (Through Hole Device)							
Package	JEDEC Code JEITA Code House Name	Fig.	IF (AV) [A]	VRRM [V]			Remarks
				40	60	200	
 32.5 × 25.0 × 4.6(mm)	— — 3S	D3	4	D4SBS4	D4SBS6	D4SBN20	
			10	D10SBS4			
			15		D15XBS6		
 37.5 × 30.0 × 4.6(mm)	— — 5S	D4	6			D6SBN20	
			15			D15XBN20	
			20		D20XBS6		
			30			D30XBN20	

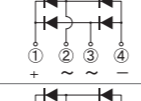
High Speed Bridge Diodes (FRD)

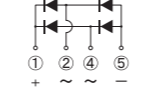
THD (Through Hole Device)							
Package	JEDEC Code JEITA Code House Name	Fig.	IF (AV) [A]	VRRM [V]			Remarks
				200	400	1000	
 32.5 × 25.0 × 4.6(mm)	— — 3S	D3	4	D4SBL20U			
 47.0 × 45.7 × 7.5(mm)	— — JC(4pin)	D7	30			D30JCB100K	

3 Phase Bridge Diodes

Package		Fig.	Type No.	Absolute Maximum Ratings				Electrical Characteristics			Halogen free	UL	Automotive
JEDEC Code JEITA Code House Name				VRRM [V]	IF (AV) [A]	Conditions Tc [°C]	IFSM [A]	Tj [°C]	Vf (max) [V]	Conditions IF [A]			
— — SVT	E15	S10VT60	600	10	137	170	150	1.05	3.5	10	—	—	—
		S10VT80	800	10	137	150	150	1.05	3.5	10	—	—	—
		S15VT60	600	15	132	200	150	1.05	5	10	—	—	—
		S15VT80	800	15	132	200	150	1.05	5	10	—	—	—
		S20VT60	600	20	128	300	150	1.05	7	10	—	—	—
		S20VT80	800	20	128	300	150	1.05	7	10	—	—	—
		S30VT60	600	30	121	400	150	1.05	10	10	—	—	—
		S30VT80	800	30	121	400	150	1.05	10	10	—	UL	—
		S30VT160	1600	30	116	350	150	1.05	10	100	—	—	—
		— — SVTA	E14	S10VTA60	600	10	137	170	150	1.05	3.5	10	—
S10VTA80	800			10	137	150	150	1.05	3.5	10	—	—	—
S15VTA60	600			15	132	200	150	1.05	5	10	—	—	—
S15VTA80	800			15	132	200	150	1.05	5	10	—	—	—
S20VTA60	600			20	128	300	150	1.05	7	10	—	—	—
S20VTA80	800			20	128	300	150	1.05	7	10	—	—	—
S30VTA60	600			30	121	400	150	1.05	10	10	—	—	—
S30VTA80	800			30	121	400	150	1.05	10	10	—	—	—
S30VTA160	1600			30	116	350	150	1.05	10	100	—	—	—
— — MG038	F7			■ MG038B150080A	800	150	125	2350	150	1.05	50	10	○
		★ MG038D150160A	1600	150	125	2350	150	1.05	50	10	○	UL	—
		■ MG038A200080A	800	200	125	2750	150	1.05	67	10	○	UL	—
		★ MG038C200160A	1600	200	125	2750	150	1.05	67	10	○	UL	—
— — MG060	F9	★ MG060C100080A	800	100	125	1700	150	1.05	34	10	○	to be certified	—
— — MG061	F10	★ MG061A150080A	800	150	125	2350	150	1.05	50	10	○	to be certified	—
		★ MG061B200080A	800	200	124	2750	150	1.05	67	10	○	to be certified	—

■ : New product ★ : Under development UL : UL recognized (UL File No. E142422)

High Speed Bridge Diodes (SBD)

THD (Through Hole Device)														
Package		Fig.	Type No.	Absolute Maximum Ratings				Electrical Characteristics			Halogen free	UL	Automotive	Remarks
JEDEC Code JEITA Code House Name				VRRM [V]	IF (AV) [A]	Conditions Tc [°C]	IFSM [A]	Tj [°C]	Vf (max) [V]	Conditions IF [A]				
— — 3S	D3	D4SBS4	40	4	116	60	150	0.55	2	2mA	—	—	—	S series
		D4SBS6	60	4	114	60	150	0.62	2	2mA	—	—	—	S series
		D4SBN20	200	4	103	60	150	0.90	2	1.5	—	—	—	N series
		D10SBS4	40	10	67	100	150	0.55	5	3.5mA	—	—	—	S series
		D15XBS6	60	15	59	150	150	0.63	7.5	6.0mA	—	—	—	S series
		D6SBN20	200	6	110	120	150	0.90	3	2	—	—	—	N series
— — 5S	D4	D15XBN20	200	15	106	200	150	0.90	7.5	5	—	—	—	N series
		D20XBS6	60	20	100	200	150	0.63	10	8.0mA	—	—	—	S series
		D30XBN20	200	30	91	350	150	0.90	15	10	—	—	—	N series

High Speed Bridge Diodes (FRD)

THD (Through Hole Device)														
Package		Fig.	Type No.	Absolute Maximum Ratings				Electrical Characteristics			Halogen free	UL	Automotive	Remarks
JEDEC Code JEITA Code House Name				VRRM [V]	IF (AV) [A]	Conditions Tc [°C]	IFSM [A]	Tj [°C]	Vf (max) [V]	Conditions IF [A]				
— — 3S	D3	D4SBL20U	200	4	108	80	150	0.98	2	10	—	—	—	
— — JC(4pin)	D7	D30JCB100K	1000	30	90	450	150	1.90	15	10	—	UL	○	K series

UL : UL recognized (UL File No. E142422)

BRIDGE DIODES

Low Vf Bridge Diodes

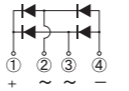

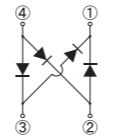

THD (Through Hole Device)							
Package	JEDEC Code JEITA Code House Name	Fig.	If (AV) [A]	VRRM [V]			Remarks
				600	800	1000	
 37.5 × 30.0 × 4.6(mm)	— — 5S	D4	15	LL15XB60			
			25	LL25XB60 ★ LK25XB60			

★ : Under development

Low Noise Bridge Diodes

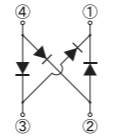
Surface Mount							
Package	JEDEC Code JEITA Code House Name	Fig.	If (AV) [A]	VRRM [V]			Remarks
				600	800	1000	
 10.6 × 10.2 × 3.1(mm)	— — 1W	C8	1.1	LN1WBA60			

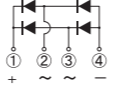
THD (Through Hole Device)

Package	JEDEC Code JEITA Code House Name	Fig.	If (AV) [A]	VRRM [V]			Remarks
				600	800	1000	
 6.2 × 10.2 × 3.0(mm)	— — 1W	C9	1.1	LN1WBA60			
 32.5 × 25.0 × 4.6(mm)	— — 3S	D3	4	LN4SB60			
 37.5 × 30.0 × 4.6(mm)	— — 5S	D4	6	LN6SB60			
			15	LN15XB60 LN15XB60H			
			25	LN25XB60			

Low Vf Bridge Diodes

THD (Through Hole Device)														
Package		Type No.	Absolute Maximum Ratings					Electrical Characteristics				Halogen free	UL	Automotive
JEDEC Code JEITA Code House Name	Fig.		VRRM [V]	If (AV) [A]	Conditions Tc [°C]	IfSM [A]	Tj [°C]	Vf (max) [V]	Conditions If [A]	Ir (max) Vr=VRRM [μA]	trr (max) [μs]			
— — 5S	D4	LL15XB60	600	15	124	200	150	0.90	7.5	10	3	—	UL	—
		LL25XB60	600	25	113	300	150	0.92	12.5	10	3	—	UL	■
		★ LK25XB60	600	25	114	603 *	-55 to 150	0.95	12.5	10	5	—	UL	—

★ : Under development * : 60Hz ■ : Please contact us. UL : UL recognized (UL File No. E142422)





Low Noise Bridge Diodes

Surface Mount-THD (Through Hole Device)															
Package		Type No.	Absolute Maximum Ratings					Electrical Characteristics				UL	Halogen free	Automotive	Remarks
JEDEC Code JEITA Code House Name	Fig.		VRRM [V]	If (AV) [A]	Conditions Tc [°C]	IfSM [A]	Tj [°C]	Vf (max) [V]	Conditions If [A]	Ir (max) Vr=VRRM [μA]	trr (max) [μs]				
— — 1W	C8(SMD) C9(DIP)	LN1WBA60	600	1.1	25 *	50	150	1.00	0.55	10	5	—	—	—	SMD-7072 DIP-7101
— — 3S	D3	LN4SB60	600	4	111	150	150	0.95	2	10	5	UL	—	—	
— — 5S	D4	LN6SB60	600	6	111	170	150	1.05	3	10	5	UL	—	—	
		LN15XB60	600	15	100	200	150	1.10	7.5	10	5	—	—	—	
		LN15XB60H	600	15	106	290	150	1.05	7.5	10	5	—	—	—	
		LN25XB60	600	25	85	350	150	1.05	12.5	10	5	—	—	—	

* : Ta UL : UL recognized (UL File No. E142422)

SCHOTTKY BARRIER DIODES

Single

Axial						
Package	JEDEC Code JEITA Code House Name	Fig.	IF(AV) [A]	VRRM[V]		Remarks
				40	60	
 3.0 × φ 2.6(mm)	— — AX057	A1	1	D1NS4	D1NS6	
 5.0 × φ 4.0(mm)	— — AX078	A4-1	2	D2S4M	D2S6M	
 7.0 × φ 4.4(mm)	— — AX14	A7	3	D3S4M	D3S6M	

Two Terminal Type

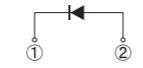
Package	JEDEC Code JEITA Code House Name	Fig.	IF(AV) [A]	VRRM[V]				Remarks
				40	60	90	150	
 28.5 × 10.0 × 4.5(mm)	— SC-91 FTO-220G	J4	5	SG5S4M	SG5S6M	SG5S9M		

Three Terminal Type

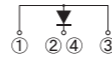
Package	JEDEC Code JEITA Code House Name	Fig.	IF(AV) [A]	VRRM[V]				Remarks
				40	60	90	150	
 41.0 × 16.0 × 5.0(mm)	TO-247AD — MTO-3PV	K7-2	40				S40T15V	
			90				S90T15V	

Single

Axial															
Package		Type No.	Absolute Maximum Ratings					Electrical Characteristics				Halogen free	Based on AEC-Q101	Automotive	Series
JEDEC Code JEITA Code House Name	Fig.		VRRM [V]	IF (AV) [A]	Conditions Ta [°C]	IFSM [A]	Tj [°C]	Vf (max) [V]	Conditions IF [A]	Ir (max) Vr=VRRM [mA]	Ct (typ) [pF]				
— — AX057	A1	D1NS4	40	1	59	30	150	0.55	1	0.8	50	—	—	—	S series
— — AX078	A4-1	D1NS6	60	1	46	30	150	0.58	1	1	53	—	—	—	S series
— — —	A7	D2S4M	40	2	122 *1	60	150	0.55	2	2	95	—	—	—	S series
— — —		D2S6M	60	2	119 *1	60	150	0.58	2	2	90	—	—	—	S series
— — —	A7	D3S4M	40	3	63	80	150	0.55	3	3.5	150	—	—	—	S series
— — AX14		D3S6M	60	3	133 *1	80	150	0.58	3	2.5	130	—	—	—	S series

*1 : TL

Two Terminal Type





Two Terminal Type															
Package		Type No.	Absolute Maximum Ratings					Electrical Characteristics				Halogen free	Based on AEC-Q101	Automotive	Series
JEDEC Code JEITA Code House Name	Fig.		VRRM [V]	IF (AV) [A]	Conditions Tc [°C]	IFSM [A]	Tj [°C]	Vf (max) [V]	Conditions IF [A]	Ir (max) Vr=VRRM [mA]	Ct (typ) [pF]				
— SC-91 FTO-220G	J4	SG5S4M	40	5	131	150	150	0.52	5	0.5	157	—	—	—	S series
— — —	J4	SG5S6M	60	5	130	120	150	0.56	5	0.5	165	—	—	—	S series
— — —		SG5S9M	90	5	124	90	150	0.75	5	0.5	140	—	—	—	S series

Three Terminal Type

Three Terminal Type															
Package		Type No.	Absolute Maximum Ratings					Electrical Characteristics				Halogen free	Based on AEC-Q101	Automotive	Series
JEDEC Code JEITA Code House Name	Fig.		VRRM [V]	IF (AV) [A]	Conditions Tc [°C]	IFSM [A]	Tj [°C]	Vf (max) [V]	Conditions IF [A]	Ir (max) Vr=VRRM [mA]	Ct (typ) [pF]				
TO-247AD — MTO-3PV	K7-2	S40T15V	150	40	131	700	150	0.92	40	0.12	595	—	—	○	N series
— — —	K7-2	S90T15V	150	90	122	1400	150	0.95	90	0.35	1690	—	—	○	N series

SCHOTTKY BARRIER DIODES

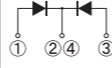
Center Tap, Common Cathode

Surface Mount											
Package	JEDEC Code JEITA Code House Name	Fig.	IF (AV) [A]	VRRM[V]						Remarks	
				30	40	60	90	100	120		150
 9.5 × 6.6 × 2.65(mm)	— SC-63 E-pack	G1-1	5	DE5SC3ML	DE5SC4M	DE5SC6M					
			10	DE10SC3L	DE10SC4						
 9.5 × 6.6 × 2.65(mm)	TO-252AB similar SC-63 FE	G3-1	6		D6FEC4ST			D6FEC10ST	D6FEC12ST	D6FEC15ST	
 13.2 × 10.2 × 4.7(mm)	— SC-83 similar STO-220	H1-1	10		DF10SC4M	DF10SC6	DF10SC9			DF10NC15	
			15		DF15SC4M			DF15JC10		DF15NC15	
			20		DF20SC4M		DF20SC9M	DF20JC10		DF20NC15	
			25			DF25SC6M					
			30	DF30SC3ML	DF30JC4 DF30SC4M	DF30JC6		DF30JC10		DF30NC15	
 13.2 × 10.2 × 4.6(mm)	— SC-83 similar FD	H2-2	10					D10FDC10ST			
			20					D20FDC10ST		D20FDC15ST	
			30		D30FDC4S			D30FDC10ST		D30FDC15ST	
			40					D40FDC10ST		D40FDC15ST	





Center Tap, Common Cathode

Surface Mount																
JEDEC Code JEITA Code House Name	Fig.	Type No.	Absolute Maximum Ratings					Electrical Characteristics					Halogen free	Based on AEC-Q101	Automotive	Series
			VRRM [V]	IF (AV) [A]	Conditions Tc [°C]	IFSM [A]	Tj [°C]	VF (max) [V]	Conditions IF [A]	Ir (max) VR=VRRM [mA]	Ct (typ) [pF]					
— SC-63 E-pack	G1-1	DE5SC3ML	30	5	110	90	150	0.45	2.5	3.5	190	—	—	■	S series	
		DE5SC4M	40	5	101	80	150	0.55	2.5	3.5	150	—	—	■	S series	
		DE5SC6M	60	5	92	80	150	0.58	2.5	2.5	130	—	—	■	S series	
		DE10SC3L	30	10	124	100	150	0.45	4	5	290	—	—	■	S series	
TO-252AB similar SC-63 FE	G3-1	DE10SC4	40	10	132	100	150	0.55	5	3.5	210	—	—	■	S series	
		D6FEC4ST	40	6	158	90	175	0.74	3	8μA	93	—	○	○	SL series	
		D6FEC10ST	100	6	154	100	175	0.86	3	8μA	60	—	○	○	SL series	
		D6FEC12ST	120	6	154	100	175	0.87	3	8μA	60	—	○	○	SL series	
		D6FEC15ST	150	6	154	100	175	0.88	3	8μA	52	—	○	○	SL series	
		DF10SC4M	40	10	125	100	150	0.55	5	3.5	180	—	—	—	S series	
— SC-83 similar STO-220	H1-1	DF10SC6	60	10	132	150	150	0.58	5	4.5	260	—	—	—	S series	
		DF10SC9	90	10	131	150	150	0.75	5	3	185	—	—	—	S series	
		DF10NC15	150	10	123	100	150	0.88	5	0.2	110	—	—	—	N series	
		DF15SC4M	40	15	129	150	150	0.55	7.5	5	340	—	—	—	S series	
		DF15JC10	100	15	126	150	150	0.86	7.5	0.6	200	—	—	—	J series	
		DF15NC15	150	15	126	150	150	0.88	7.5	0.3	155	—	—	—	N series	
		DF20SC4M	40	20	122	230	150	0.55	10	7.5	390	—	—	—	S series	
		DF20SC9M	90	20	111	200	150	0.75	10	10	370	—	—	—	S series	
		DF20JC10	100	20	121	200	150	0.86	10	0.7	260	—	—	—	J series	
		DF20NC15	150	20	121	200	150	0.88	10	0.4	200	—	—	—	N series	
		DF25SC6M	60	25	115	300	150	0.58	12.5	10	490	—	—	—	S series	
		DF30SC3ML	30	30	119	350	150	0.48	15	10	820	—	—	—	S series	
		DF30JC4	40	30	115	250	150	0.61	15	0.7	560	—	—	—	J series	
		DF30SC4M	40	30	112	360	150	0.55	15	10	590	—	—	—	S series	
		DF30JC6	60	30	108	250	150	0.69	15	0.7	490	—	—	—	J series	
		DF30JC10	100	30	116	300	150	0.86	15	1	390	—	—	—	J series	
		DF30NC15	150	30	115	300	150	0.88	15	0.5	300	—	—	—	N series	
		DF40SC3L	30	40	112	400	150	0.45	15	17	1200	—	—	—	S series	
		DF40SC4	40	40	106	350	150	0.55	20	14	860	—	—	—	S series	
		— SC-83 similar FD	H2-2	D10FDC10ST	100	10	158	150	175	0.86	5	15μA	104	—	○	○
D20FDC10ST	100			20	119	250	150	0.86	10	30μA	185	—	○	○	N series	
D20FDC15ST	150			20	118	250	150	0.88	10	30μA	159	—	—	○	N series	
D30FDC4S	40			30	114	300	150	0.55	15	1.5	415	—	○	○	S series	
D30FDC10ST	100			30	108	300	150	0.86	15	40μA	242	—	—	○	N series	
D30FDC15ST	150			30	107	300	150	0.88	15	40μA	209	—	—	○	N series	
D40FDC10ST	100			40	105	400	150	0.86	20	60μA	360	—	—	○	N series	
D40FDC15ST	150			40	103	400	150	0.88	20	60μA	315	—	—	○	N series	

■ : Please contact us.

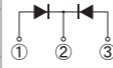
SCHOTTKY BARRIER DIODES

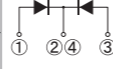
Center Tap, Common Cathode

Three Terminal Type												Remarks	
Package	JEDEC Code JEITA Code House Name	Fig.	IF (AV) [A]	VRRM[V]						Remarks			
				15	30	40	60	90	100		120		150
 28.5 × 10.0 × 4.5(mm)	SC-91 FTO-220G	J9	8			SG8SC4M							
			10		SG10SC3LM	SG10SC4M	SG10SC6M	SG10SC9M			SG10TC15M		
			15		SG15SC4M	SG15SC6M							
			20		SG20SC3LM	SG20SC4M	SG20JC6M SG20SC6M	SG20SC9M	SG20TC10M	SG20TC12M	SG20TC15M		
			30		SG30SC3LM	SG30SC4M	SG30JC6M SG30SC6M		SG30TC10M	SG30TC12M	SG30TC15M		
 41.0 × 16.0 × 5.0(mm)	TO-247AD MTO-3PT	K5-2	20					S20SC9MT					
			30			S30SC4MT	S30SC6MT			S30TC15T			
			40	S40HC1R5T									
			60	S60HC1R5T	S60HC3T S60SC3LT	S60SC4MT	S60SC6MT						
 41.0 × 16.0 × 5.0(mm)	TO-247AD MTO-3PV	K7-1	60						S60JC10V				

Center Tap, Common Cathode



Three Terminal Type																
JEDEC Code JEITA Code House Name	Fig.	Type No.	Absolute Maximum Ratings					Electrical Characteristics					Halogen free	Based on AEC-Q101	Automotive	Series
			VRRM [V]	IF (AV) [A]	Conditions Tc [°C]	IFSM [A]	Tj [°C]	Vf (max) [V]	Conditions IF [A]	Ir (max) Vr=VRRM [mA]	Ct (typ) [pF]					
SC-91 FTO-220G	J9	SG8SC4M	40	8	155	80	175	0.56	4.0	0.3	100	-	-	-	S series	
		SG10SC3LM	30	10	136	150	150	0.45	4.0	5	310	-	-	-	S series	
		SG10SC4M	40	10	150	150	175	0.52	5.0	0.5	157	-	-	-	S series	
		SG10SC6M	60	10	145	140	175	0.56	5.0	0.5	165	-	-	-	S series	
		SG10SC9M	90	10	139	150	175	0.75	5.0	0.5	140	-	-	-	S series	
		SG10TC15M	150	10	153	120	175	0.88	5.0	15μA	92	-	-	-	SL series	
		SG15SC4M	40	15	117	150	150	0.52	7.5	0.8	230	-	-	-	S series	
		SG15SC6M	60	15	113	180	150	0.61	7.5	0.6	185	-	-	-	S series	
		SG20SC3LM	30	20	124	250	150	0.45	8.0	9	570	-	-	-	S series	
		SG20SC4M	40	20	115	200	150	0.52	10.0	1.1	315	-	-	-	S series	
		SG20JC6M	60	20	106	200	150	0.69	10.0	0.1	250	-	-	-	J series	
		SG20SC6M	60	20	107	200	150	0.61	10.0	0.8	250	-	-	-	S series	
		SG20SC9M	90	20	112	200	150	0.75	10.0	1	245	-	-	-	S series	
		SG20TC10M	100	20	140	200	175	0.86	10.0	30μA	185	-	-	-	SL series	
		SG20TC12M	120	20	137	200	175	0.87	10.0	30μA	175	-	-	-	SL series	
		SG20TC15M	150	20	136	200	175	0.88	10.0	30μA	159	-	-	-	SL series	
		SG30SC3LM	30	30	117	350	150	0.45	12.5	15	960	-	-	-	M series	
		SG30SC4M	40	30	101	300	150	0.55	15.0	1.5	415	-	-	-	S series	
		SG30JC6M	60	30	90	250	150	0.69	15.0	0.15	325	-	-	-	J series	
		SG30SC6M	60	30	100	300	150	0.61	15.0	1.2	385	-	-	-	S series	
		SG30TC10M	100	30	126	300	175	0.86	15.0	40μA	242	-	-	-	SL series	
		SG30TC12M	120	30	122	300	175	0.87	15.0	40μA	228	-	-	-	SL series	
		SG30TC15M	150	30	122	300	175	0.88	15.0	40μA	209	-	-	-	SL series	
		SG40TC10M	100	40	116	350	175	0.86	20.0	60μA	362	-	-	-	SL series	
		SG40TC12M	120	40	112	350	175	0.87	20.0	60μA	336	-	-	-	SL series	
		TO-247AD MTO-3PT	K5-2	S20SC9MT	90	20	136	200	150	0.75	10.0	1	245	-	-	-
S30SC4MT	40			30	132	300	150	0.55	15.0	1.5	410	-	-	-	S series	
S30SC6MT	60			30	129	300	150	0.61	15.0	1.2	385	-	-	-	S series	
S30TC15T	150			30	128	300	150	0.88	15.0	40μA	209	-	-	-	N series	
S40HC1R5T	15			40	111	450	125	0.41	20.0	10	960	-	-	-	H series	
S60HC1R5T	15			60	110	600	125	0.41	30.0	15	1400	-	-	-	H series	
S60HC3T	30			60	112	650	125	0.40	30.0	20	1100	-	-	-	H series	
S60SC3LT	30			60	138	650	150	0.48	30.0	25	1600	-	-	-	S series	
S60SC4MT	40			60	127	500	150	0.55	30.0	3	790	-	-	-	S series	
S60SC6MT	60	60	121	470	150	0.67	30.0	2	640	-	-	-	S series			
TO-247AD MTO-3PV	K7-1	S60JC10V	100	60	118	500	150	0.95	30.0	0.2	695	-	-	○	J series	

SCHOTTKY BARRIER DIODES

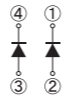
Array

Surface Mount						
Package	JEDEC Code JEITA Code House Name	Fig.	I _F (AV) [A]	V _{RRM} [V]		Remarks
				40	60	
 7.0 × 4.7 × 2.6(mm)	TO-269AA — 1Z	C2-2	1.2	S1ZAS4		

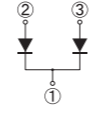
Diode Module

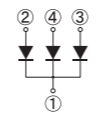
Diode Module						
Package	JEDEC Code JEITA Code House Name	Fig.	I _F (AV) [A]	V _{RRM} [V]		Remarks
				40	60	
 43.0 × 27.0 × 21.0(mm)	— — Module	F1	120	D120SC4M	D120SC6M	
240			D240SC4M	D240SC6M		
 43.0 × 27.0 × 21.0(mm)		F3-1	180	D180SC4M	D180SC6M	
			360	D360SC4M	D360SC6M	

Array







Surface Mount															
Package		Type No.	Absolute Maximum Ratings					Electrical Characteristics				Halogen free	Based on AEC-Q101	Automotive	Series
JEDEC Code JEITA Code House Name	Fig.		V _{RRM} [V]	I _F (AV) [A]	Conditions T _a [°C]	I _{FSM} [A]	T _j [°C]	V _F (max) [V]	Conditions I _F [A]	I _R (max) V _R =V _{RRM} [mA]	C _t (typ) [pF]				
TO-269AA — 1Z	C2-2	S1ZAS4	40	1.2	47	40	150	0.55	1	1	65	—	—	—	S series

Diode Module

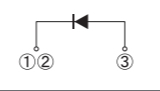
Diode Module															
Package		Type No.	Absolute Maximum Ratings					Electrical Characteristics				Halogen free	Based on AEC-Q101	Automotive	Series
JEDEC Code JEITA Code House Name	Fig.		V _{RRM} [V]	I _F (AV) [A]	Conditions T _c [°C]	I _{FSM} [A]	T _j [°C]	V _F (max) [V]	Conditions I _F [A]	I _R (max) V _R =V _{RRM} [mA]	C _t (typ) [pF]				
— — Module	F1	D120SC4M	40	120	90	800	125	0.58	60	40	2.1	—	—	—	S series
		D120SC6M	60	120	85	800	125	0.67	60	40	2.2	—	—	—	S series
		D240SC4M	40	240	77	1600	125	0.6	120	80	4.2	—	—	—	S series
		D240SC6M	60	240	71	1600	125	0.67	120	80	4.4	—	—	—	S series
	F3-1	D180SC4M	40	180	83	800	125	0.58	60	40	2.1	—	—	—	S series
		D180SC6M	60	180	78	800	125	0.67	60	40	2.2	—	—	—	S series
		D360SC4M	40	360	64	1600	125	0.6	120	80	4.2	—	—	—	S series
		D360SC6M	60	360	58	1600	125	0.67	120	80	4.4	—	—	—	S series

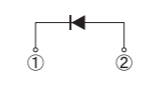
FAST RECOVERY DIODES



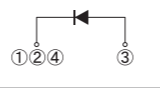

Single

Two Terminal Type											
Package	JEDEC Code JEITA Code House Name	Fig.	IF(AV) [A]	VRRM[V]			Remarks				
				200	400	600					
 28.5 × 10.0 × 4.5(mm)	SC-91A FTO-220	J1	3			SF3L60U					
			5			SF5L60U					
			10			SF10L60U					
			20			SF20L60U					
			3			SF3K60M					
 28.5 × 10.0 × 4.5(mm)	SC-91 FTO-220AG	J3	5		SF5L40UM	SF5K60M					
			8			SF8K60USM SF8K60M					
			10			SF10K60M SF10L60MVM SF10L60MSM SF10L60AM					
			20			SF20K60M SF20L60MVM SF20L60MSM SF20L60AM					
			 28.5 × 10.0 × 4.5(mm)	SC-91 FTO-220G	J4	5		SG5L20USM			
						10		SG10L20USM			
			 41.0 × 16.0 × 5.0(mm)	TO-247AD MTO-3PT	K2	20				S20K60T	
						30				S30K60T	

■ : New product

Three Terminal Type							
Package	JEDEC Code JEITA Code House Name	Fig.	IF(AV) [A]	VRRM[V]			Remarks
				600	1000	1200	
 41.0 × 16.0 × 5.0(mm)	TO-247AD MTO-3PV	K6	20		S20K100V		
			30	S30K60V	S30K100V		

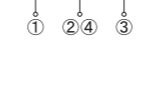
Center Tap, Common Cathode

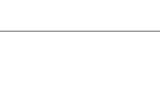
Surface Mount								
Package	JEDEC Code JEITA Code House Name	Fig.	IF(AV) [A]	VRRM[V]				Remarks
				200	300	400	600	
 9.5 × 6.6 × 2.65(mm)	SC-63 E-pack	G1-1	5	DE5LC20U				
			10	DF10LC20U	DF10LC30			
 13.2 × 10.2 × 4.7(mm)	SC-83 similar STO-220	H1-1	20	DF20LC20US	DF20LC30			
			20	D20FDC20L D20FDC20LUS				
 13.2 × 10.2 × 4.6(mm)	SC-83 similar FD	H2-2	20	D20FDC20L D20FDC20LUS				
			20	D20FDC20LUS				

■ : Please contact us.

Single

Two Terminal Type															
JEDEC Code JEITA Code House Name	Fig.	Type No.	Absolute Maximum Ratings					Electrical Characteristics				Halogen free	Based on AEC-Q101	Automotive	Series
			VRRM [V]	IF (AV) [A]	Conditions Tc [°C]	IFSM [A]	Tj [°C]	Vf (max) [V]	Conditions IF [A]	Ir (max) Vr=VRRM [μA]	ttr (max) [ns]				
SC-91A FTO-220	J1	SF3L60U	600	3	115	40	150	3.00	3	25	20	-	-	-	-
		SF5L60U	600	5	96	60	150	3.00	5	25	25	-	-	-	-
		SF10L60U	600	10	85	120	150	3.00	10	25	25	-	-	■	-
		SF20L60U	600	20	68	180	150	3.00	20	25	35	-	-	■	-
SC-91 FTO-220AG	J3	SF3K60M	600	3	132	90	150	1.45	3	10	80	-	-	-	K series
		SF5L40UM	400	5	121	100	150	1.25	5	10	30	-	-	■	-
		SF5K60M	600	5	119	120	150	1.50	5	10	85	-	-	■	K series
		SF8K60USM	600	8	70	60	150	3.60	8	50	25	-	-	-	US series
		SF8K60M	600	8	108	150	150	1.50	8	10	90	-	-	■	K series
		SF10K60M	600	10	106	180	150	1.50	10	10	95	-	-	-	K series
		SF10L60MVM	600	10	119	200	150	1.10	10	10	115	-	-	■	ML series
		SF10L60MSM	600	10	110	160	150	1.37	10	10	60	-	-	■	ML series
		SF10L60AM	600	10	106	180	-55 to 150	2.10	10	10	28	-	-	-	A series
		SF20K60M	600	20	96	240	150	1.50	20	10	95	-	-	-	K series
		SF20L60MVM	600	20	106	250	150	1.10	20	10	130	-	-	■	ML series
		SF20L60MSM	600	20	96	220	150	1.37	20	10	70	-	-	■	ML series
SF20L60AM	600	20	77	260	-55 to 150	2.10	20	10	35	-	-	-	A series		
SC-91 FTO-220G	J4	SG5L20USM	200	5	125	90	150	0.96	5	10	25	-	-	-	-
		SG10L20USM	200	10	101	200	150	0.96	10	10	25	-	-	-	-
TO-247AD MTO-3PT	K2	S20K60T	600	20	121	300	150	1.50	20	10	95	-	-	-	K series
		S30K60T	600	30	123	450	150	1.50	30	10	100	-	-	-	K series

■ : New product ■ : Please contact us.

Three Terminal Type															
JEDEC Code JEITA Code House Name	Fig.	Type No.	Absolute Maximum Ratings					Electrical Characteristics				Halogen free	Based on AEC-Q101	Automotive	Series
			VRRM [V]	IF (AV) [A]	Conditions Tc [°C]	IFSM [A]	Tj [°C]	Vf (max) [V]	Conditions IF [A]	Ir (max) Vr=VRRM [μA]	ttr (max) [ns]				
TO-247AD MTO-3PV	K6	S20K100V	1000	20	127	550	150	2.10	20	10	120	-	-	○	K series
		S30K60V	600	30	108	450	150	1.50	30	10	100	-	-	○	K series
		S30K100V	1000	30	116	600	150	2.10	30	10	120	-	-	○	K series

Center Tap, Common Cathode





Surface Mount															
JEDEC Code JEITA Code House Name	Fig.	Type No.	Absolute Maximum Ratings					Electrical Characteristics				Halogen free	Based on AEC-Q101	Automotive	Series
			VRRM [V]	IF (AV) [A]	Conditions Tc [°C]	IFSM [A]	Tj [°C]	Vf (max) [V]	Conditions IF [A]	Ir (max) Vr=VRRM [μA]	ttr (max) [ns]				
SC-63 E-pack	G1-1	DE5LC20U	200	5	81	50	150	0.98	2.5	10	35	-	-	■	-
SC-83 similar STO-220	H1-1	DF10LC20U	200	10	127	80	150	0.98	5	10	35	-	-	-	-
		DF10LC30	300	10	124	80	150	1.30	5	25	30	-	-	-	-
		DF20LC20US	200	20	125	180	150	0.96	10	10	25	-	-	-	-
		DF20LC30	300	20	124	180	150	1.30	10	25	30	-	-	-	-
SC-83 similar FD	H2-2	D20FDC20L	200	20	113	100	175	1.20	10	10	30	-	-	○	-
		D20FDC20LUS	200	20	125	180	150	0.96	10	10	25	-	-	○	-

■ : Please contact us.

FAST RECOVERY DIODES

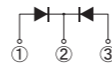
Center Tap, Common Cathode

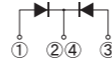
Three Terminal Type

Package	JEDEC Code JEITA Code House Name	Fig.	I _{F(AV)} [A]	V _{RRM} [V]				Remarks
				200	300	400	600	
 28.5 × 10.0 × 4.5(mm)	— SC-91 FTO-220AG	J8-1	5			SF5LC40UM		
			10			SF10LC40UM	SF10KC60M	
			20		SF20LC30M		SF20KC60M	
 28.5 × 10.0 × 4.5(mm)	— SC-91 FTO-220G	J9	5	SG5LC20USM				
			10	SG10LC20USM				
			20	SG20LC20USM				
 41.0 × 16.0 × 5.0(mm)	TO-247AD — MTO-3PT	K5-2	20	S20LC20UST	S20LC30T	S20LC40UT	S20LC60UST	
				S20LC40UV	S20LC60USV			
 41.0 × 16.0 × 5.0(mm)	TO-247AD — MTO-3PV	K7-1	20			S20LC40UV	S20LC60USV	

Center Tap, Common Cathode

Three Terminal Type







JEDEC Code JEITA Code House Name	Package	Fig.	Type No.	Absolute Maximum Ratings				Electrical Characteristics				Halogen free	Based on AEC-Q101	Automotive	Series	
				V _{RRM} [V]	I _{F(AV)} [A]	Conditions T _C [°C]	I _{F(SM)} [A]	T _J [°C]	V _F (max) [V]	Conditions I _F [A]	I _R (max) V _R =V _{RRM} [μA]					t _{rr} (max) [ns]
— SC-91 FTO-220AG	J8-1		SF5LC40UM	400	5	132	80	150	1.25	2.5	10	30	—	—	—	—
			SF10LC40UM	400	10	120	100	150	1.25	5	10	30	—	—	—	—
			SF10KC60M	600	10	109	120	150	1.50	5	10	85	—	—	■	K series
			SF20LC30M	300	20	107	250	150	1.30	10	25	30	—	—	—	—
— SC-91 FTO-220G	J9		SF20KC60M	600	20	97	180	150	1.50	10	10	95	—	—	■	K series
			SG5LC20USM	200	5	133	70	150	0.96	2.5	10	25	—	—	—	—
			SG10LC20USM	200	10	122	90	150	0.96	5	10	25	—	—	—	—
TO-247AD — MTO-3PT	K5-2		SG20LC20USM	200	20	95	150	150	0.96	10	10	25	—	—	—	—
			S20LC20UST	200	20	126	120	150	0.96	10	10	25	—	—	—	—
			S20LC30T	300	20	124	220	150	1.30	10	25	30	—	—	—	—
TO-247AD — MTO-3PV	K7-1		S20LC40UT	400	20	123	130	150	1.25	10	10	30	—	—	—	—
			S20LC60UST	600	20	63	60	150	3.60	10	50	25	—	—	—	—
			S20LC40UV	400	20	123	200	150	1.25	10	10	30	—	—	○	—
S20LC60USV	600	20	65	60	150	3.60	10	50	25	—	—	○	—			

■ : Please contact us.

THYRISTORS

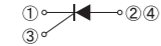

The Thyristor, in its normal state, will block an applied voltage in either direction, but when an appropriate current pulse is applied to the gate, current will flow through the anode to the cathode thus turning on power to the load circuit. The Thyristor has a planar passivation, and is available in both the general reverse-blocking type and the type without reverse voltage. The Thyristor without reverse voltage is suitable for a circuit limiting inrush current.

Thyristors

Package	 10.0 × 6.6 × 2.3(mm)	 28.5 × 10.0 × 4.5(mm)		
JEDEC Code JEITA Code House Name	TO-252AA — FB	— SC-91 FTO-220AG		
Fig.	G2-2	J8-5		
Internal Circuit				
$I_T(AV)$ [A]	3	5	5	8
V_{DRM} [V]	400	KC3FB40H	KC5FB40H	
	600		KC5FB60H KC5FB60HR KC5FB60HRT	 KC5SF60HRT
	800			 KC8SF80

 : New product

Thyristors

Package		Type No.	Absolute Maximum Ratings						Electrical Characteristics					Halogen free	Based on AEC-Q101	Automotive
JEDEC Code JEITA Code House Name	Fig.		V_{DRM} [V]	V_{RRM} [V]	$I_T(AV)$ [A]	Conditions T_C [°C]	I_{TSM} [A]	T_J [°C]	$V_{TM(max)}$ [V]	Conditions I_{TM} [A]	$V_{GT(max)}$ [V]	$I_{GT(max)}$ [μA]	$I_H(max)$ [mA]			
TO-252AA — FB	G2-2	KC3FB40H	400	400	3	111	40	-40 to 125	1.4	4	0.8	100	5	—	—	—
		KC5FB40H	400	400	5	101	65	-40 to 125	1.6	10	0.8	200	typ.1	—	—	—
		KC5FB60H	600	600	5	98	90	-40 to 125	1.8	15	0.8	100	5	—	—	—
		KC5FB60HRT	600	—	5	98	90	-40 to 125	1.8	15	0.8	100	5	—	—	—
— SC-91 FTO-220AG	J8-5	 KC5SF60HRT	600	—	5	127	82	-40 to 150	1.8	15	0.8	100	5	—	—	—
		 KC8SF80	800	800	8	130	120	-40 to 150	1.5	20	1.0	15mA	100	—	—	—

 : New product



SIDACs

SIDAC series are semiconductor devices energized by the addition of a specific voltage. They are commonly used for switching devices or pulse generating devices.

Bi-directional (K1V series)

- Features
 1. Symmetrical characteristics.
 2. Operating directly from the AC mains, and can be used in all kinds of pulse generating circuits.
 3. The glass passivation ensures high reliability.



- Applications
 1. Pulse generation : gas igniters,HID(high intensity discharge)lamp drive circuit,etc.
 2. AC switching : drive circuit for switching power supplies,voltage detecting circuits,etc.
 3. Over voltage protection : AC line surge protection,capacitor rupture prevention,etc.

Package			
JEDEC Code	DO-214AC	-	-
JEITA Code	-	-	-
House Name	1F	AX06	AX10
Fig.	B4-3	A2-1	A5-3
Internal Circuit	①—N—②		
V _{DRM} [V]	5	K1VZL09	
	15	K1VZL20	
	90	K1V(A)10 K1V(A)11 K1V(A)12	K1V10 K1V11 K1V12
	115	K1V(A)16	K1V14
	180		K1V22 K1V24 K1V26
	270		K1V22(W) K1V24(W) K1V26(W) K1V36(W) K1V38(W)

Uni-directional (G1V series)

- Features
 1. Uni-directional characteristics.
 2. Smaller package than bi-directional SIDAC.
 3. Switching operation from DC power for pulse generation.
 4. The glass passivation ensures high reliability.

- Applications
 1. Pulse generation : gas igniters,negative ion generators, HID(high intensity discharge) lamp drive circuit,etc.
 2. Over voltage protection : DC line surge protection.

Package			
JEDEC Code	DO-214AC	-	-
JEITA Code	-	-	-
House Name	1F	AX06	AX078
Fig.	B3-3	A2-3	A4-3
Internal Circuit	①—N—②		
V _{DRM(A)} [V]	70	G1VL8C	G1V(A)8C
	90	G1VL10C	G1V(A)10C
	100		G1V(A)12C
	110		G1V(A)13C
	115		G1V(A)15C
	120	G1VL15C	G1V(A)14C
	170	G1VL20C	G1V(A)20C
	210	G1VL22C G1VL24C	

Bi-directional (K1V series)

Surface Mount		Type No.	Absolute Maximum Ratings					Electrical Characteristics					Halogen free	Automotive		
JEDEC Code	Fig.		V _{DRM}	I _T	Conditions	T _{stg}	T _J	V _{BO}	I _{DRM}	Conditions	I _{BO}	I _H			V _T	Conditions
JEITA Code	House Name	[V]	[A]	T _L [°C]	[°C]	[°C]	[V]	[μA]	V _D [V]	[mA]	[mA]	[V]	I _T [A]			
DO-214AC	B4-3	K1VZL09	5	0.5	110	-40 to 125	125	8 to 12	5	5	20	20	1.2	0.5	-	-
1F		K1VZL20	15	0.5	110	-40 to 125	125	18 to 22	5	15	20	20	1.2	0.5	-	-

Axial

Package		Type No.	Absolute Maximum Ratings							Electrical Characteristics					Halogen free	Automotive
JEDEC Code	Fig.		V _{DRM}	I _T	Conditions	I _{TRM}	I _{TRM}	Conditions	di _T /dt	T _J	V _{BO}	I _H	V _T	Conditions		
JEITA Code	House Name	[V]	[A]	T _L [°C]	[A]	[A]	f [Hz]	[A/μs]	[°C]	[V]	[mA]	[V]	I _T [A]			
-	AX06	K1V(A)10	90	1	109	16	60	60	50	125	95 to 113	50	1.6	1	-	-
		K1V(A)11	90	1	109	16	60	60	50	125	104 to 118	50	1.6	1	-	-
		K1V(A)12	90	1	109	16	60	60	50	125	110 to 125	50	1.6	1	-	-
		K1V(A)16	115	1	98	16	60	60	50	125	145 to 170	50	1.6	1	-	-
-	A5-3	K1V10	90	1	112	20	80	60	80	125	95 to 113	50	1.5	1	-	-
		K1V11	90	1	112	20	80	60	80	125	104 to 118	50	1.5	1	-	-
		K1V12	90	1	112	20	80	60	80	125	110 to 125	50	1.5	1	-	-
		K1V14	115	1	109	20	80	60	80	125	125 to 150	30	1.5	1	-	-
		K1V22	180	1	108	20	50	60	80	125	200 to 230	20	1.5	1	-	-
		K1V24	180	1	108	20	50	60	80	125	220 to 250	20	1.5	1	-	-
	AX10	K1V26	180	1	108	20	50	60	80	125	240 to 270	20	1.5	1	-	-
		K1V22(W)	180	1	91	16	50	60	80	125	200 to 230	50	3	1	-	-
		K1V24(W)	180	1	91	16	50	60	80	125	220 to 250	50	3	1	-	-
		K1V26(W)	180	1	91	16	50	60	80	125	240 to 265	50	3	1	-	-
		K1V36(W)	270	1	92	13	40	60	50	125	340 to 380	50	3	1	-	-
		K1V38(W)	270	1	92	13	40	60	80	125	360 to 400	50	3	1	-	-

Uni-directional (G1V series)

Surface Mount		Type No.	Absolute Maximum Ratings					Electrical Characteristics					Halogen free	Automotive	
JEDEC Code	Fig.		V _{DRM(A)}	I _T	Conditions	I _{TRM}	Conditions	di _T /dt	T _J	V _{BO(A)}	I _{H(A),(K)}	V _{T(A),(K)}			Conditions
JEITA Code	House Name	[V]	[A]	T _L [°C]	[A]	f [Hz]	[A/μs]	[°C]	[V]	[mA]	[V]	I _T [A]			
DO-214AC	1F	G1VL8C	70	1	98	80	60	150	125	75 to 90	100	1.5	1	-	-
		G1VL10C	90	1	98	150	60	150	125	95 to 110	100	1.5	1	-	-
		G1VL15C	120	1	98	120	60	150	125	142 to 157	60	1.5	1	-	-
		G1VL20C	170	1	98	120	60	150	125	190 to 210	60	1.5	1	-	-
		G1VL22C	190	1	98	280	5	150	125	210 to 230	60	1.5	1	-	-
		G1VL24C	190	1	98	280	5	150	150	230 to 250	60	1.5	1	-	-

Axial

Package		Type No.	Absolute Maximum Ratings							Electrical Characteristics					Halogen free	Automotive
JEDEC Code	Fig.		V _{DRM(A)}	I _T	Conditions	I _{TRM}	Conditions	di _T /dt	T _J	V _{BO(A)}	I _{H(A),(K)}	V _{T(A),(K)}	Conditions			
JEITA Code	House Name	[V]	[A]	T _L [°C]	[A]	f [Hz]	[A/μs]	[°C]	[V]	[mA]	[V]	I _T [A]				
-	AX06	G1V(A)8C	70	1	98	80	60	80	125	75 to 90	100	1.5	1	-	-	
		G1V(A)10C	90	1	98	80	60	80	125	95 to 110	60	1.5	1	-	-	
		G1V(A)12C	100	1	98	80	60	80	125	110 to 130	60	1.5	1	-	-	
		G1V(A)13C	110	1	98	80	60	80	125	120 to 138	60	1.5	1	-	-	
		G1V(A)14C	120	1	98	80	60	80	125	130 to 150	60	1.5	1	-	-	
		G1V(A)15C	115	1	98	80	60	80	125	142 to 157	60	1.5	1	-	-	
-	AX078	G1V(A)20C	170	1	98	80	60	80	125	190 to 210	60	1.5	1	-	-	
		G1V(B)20C	170	1	102	120	60	220	150	190 to 210	60	1.5	1	-	-	
		G1V(B)22C	190	1	98	160	60	220	125	210 to 230	60	1.5	1	-	-	
		G1V(B)24C	210	1	102	120	60	220	150	230 to 250	60	1.5	1	-	-	









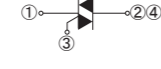
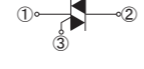

TRIACs

TRIACs are bidirectional Thyristors.

Our TRIACs are easy to use for motor and heater controls due to balanced gate sensitivity and (di/dt)_c.

Our lineup ranges from V_{DRM}=600 to 800V, I_{T(RMS)}=3 to 20A.

TRIACs (Triode for Alternating Current)







Package	 10.0 × 6.6 × 2.3(mm)	 28.5 × 10.0 × 4.5(mm)
JEDEC Code JEITA Code House Name	TO-252AA — FB	— SC-91 FTO-220AG
Fig.	G2-3	J8-4
Internal Circuit		
V _{DRM} [V]	600	
I _{T(RMS)} [A]	3	 KD3FB60
	5	 KD3SF60E  KD3SF60
	8	 KD5SF60
	12	 KD8SF60
	16	 KD12SF60
	20	 KD16SF60  KD20SF60

 : New product

TRIACs (Triode for Alternating Current)

Surface Mount		Type No.	Absolute Maximum Ratings			Electrical Characteristics						Halogen free	Based on AEC-Q101	Automotive
JEDEC Code JEITA Code House Name	Fig.		V _{DRM} [V]	I _T (RMS) [A]	T _J [°C]	V _{TM} (max) [V]	Conditions I _{TM} [A]	V _{GT} (max) (I, II, III)* [V]	I _{GT} (max) (I, II, III)* [mA]	(dv/dt) _c (min) (T _j =150°C, V _D =2/3V _{DRM}) [V/μs]	Conditions (di/dt) _c [A/ms]			
TO-252AA — FB	G2-3	 KD3FB60	600	3	-40 to 150	1.7	4.5	1.5	15	1	-1.5	—	—	—

 : New product * : Operation mode IV is not guaranteed.

Two Terminal Type		Type No.	Absolute Maximum Ratings			Electrical Characteristics						Halogen free	Based on AEC-Q101	Automotive
JEDEC Code JEITA Code House Name	Fig.		V _{DRM} [V]	I _T (RMS) [A]	T _J [°C]	V _{TM} (max) [V]	Conditions I _{TM} [A]	V _{GT} (max) (I, II, III)* [V]	I _{GT} (max) (I, II, III)* [mA]	(dv/dt) _c (min) (T _j =150°C, V _D =2/3V _{DRM}) [V/μs]	Conditions (di/dt) _c [A/ms]			
— SC-91 FTO-220AG	J8-4	 KD3SF60E	600	3	-40 to 150	1.5	4.5	1.5	10	—	—	—	—	—
		 KD3SF60	600	3	-40 to 150	1.5	4.5	1.5	20	1	-1.5	—	—	—
		 KD5SF60	600	5	-40 to 150	1.8	7	1.5	20	1	-2.5	—	—	—
		 KD8SF60	600	8	-40 to 150	1.6	12	1.5	30	1	-4.0	—	—	—
		 KD12SF60	600	12	-40 to 150	1.6	20	1.5	30	1	-6.0	—	—	—
		 KD16SF60	600	16	-40 to 150	1.5	25	1.5	30	1	-8.0	—	—	—
 KD20SF60	600	20	-40 to 150	1.4	30	1.5	30	1	-10.0	—	—	—	—	

 : New product * : Operation mode IV is not guaranteed.

Operation Mode	Terminal Characteristics		
	① T1	②④ T2	③ G
I	—	+	+
II	—	+	—
III	+	—	—
IV	+	—	+



SURGE ABSORBERS

Surge Absorbers are semiconductor devices of the Thyristor type that turns on when triggered by their rated voltage. They are commonly used for lightning surge protection in communications equipment.

Thyristor Surge Suppressors

- Features**
1. Bi-directional or uni-directional characteristics.
 2. High speed response.
 3. Large surge current capacity.
 4. Repetitive use against surges is possible.

- Applications**
1. Lightning surge adsorption for communications circuits.
 2. Lightning surge adsorption for transmitters and switchboards.
 3. Surge protection for ISDN terminals.

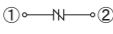
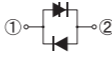
Series	KL Series	KU Series	KP Series
Package	 5.0 × 2.5 × 2.0(mm)	 5.1 × 3.75 × 2.0(mm)	 7.6 × 4.0 × 2.8(mm)
JEDEC Code JEITA Code House Name	DO-214AC - 1F	DO-214AA similar - M2F	- - 2F
Fig.	B4-3	B7 B8	B9-4
Internal Circuit			
Off-state Voltage V _D [V]	5	KL3Z07	
	15	KL3Z18	
	58	KL3L07	
	63		KU10L08
	70		KU4F8
	90		KU10NU11
	92		KP20NU11 KP40NU11
	100		KU4F12
	115		KU10NU13
	120	KL3N14	KU10N14 KU15N14
	175	KL3R20	
	180		KP40RU22
	190		KU10R23NS
	220		KU10R27NS
250		KU10R29NS	
275		KU5S31NS KU10S31NS KU10S35NS	

Varistor

- Features**
1. Bi-directional surge absorption is possible.
 2. Low junction capacitance.

- Applications**
1. Telephone set surge absorption.
 2. Digital communications circuit surge absorption.
 3. ISDN terminal surge absorption.

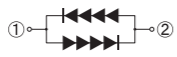
Package	 5.0 × 2.5 × 2.0(mm)
JEDEC Code JEITA Code House Name	DO-214AC - 1F
Fig.	B4-1
Internal Circuit	
V _F [V]	2.3 ± 0.25
	VR61F1

Thyristor Surge Suppressors

Package		Type No.	Absolute Maximum Ratings				Electrical Characteristics			Halogen free	UL	Automotive
JEDEC Code JEITA Code House Name	Fig.		V _{BRM} [V]	I _{TSM} [A]	Conditions [μs]	T _J [°C]	V _{BO} (min) [V]	I _H (min) [mA]	C _t (max) [pF]			
DO-214AC - 1F	B4-3	KL3Z07	5	30	10/1000	125	5.5 *1	50	-	-	-	
		KL3Z18	15	30	10/1000	125	15.5 *1	50	-	-	-	
		KL3L07	58	30	10/1000	125	65	100	90	-	-	
		KL3N14	120	30	10/1000	125	130	100	50	-	-	
		KL3R20	175	30	10/1000	125	180	100	30	-	-	
DO-214AA similar - M2F	B7	KU10L08	63	100	10/1000	125	70	100	180	-	UL	-
		KU4F8	70	40	10/1000	125	75	100	100	-	-	-
	B7	KU10NU11	60	100	10/1000	125	100	150	-	-	-	-
		KU4F12	100	40	10/1000	125	110	100	100	-	-	-
		KU10NU13	60	100	10/1000	125	120	100	-	-	-	-
		KU10N14	120	100	10/1000	125	125	100	140	-	UL	-
		KU15N14	120	150	10/1000	125	125	100	110	-	UL	-
		KU10R23NS	190	100	10/1000	125	290 *2	100	90	-	-	-
		KU10R27NS	220	100	10/1000	125	320 *2	100	70	-	UL	-
		KU10R29NS	250	100	10/1000	125	400 *2	100	70	-	UL	-
B9-4	KU5S31NS	275	50	10/1000	125	420 *2	150	70	-	-	-	
	KU10S31NS	275	100	10/1000	125	420 *2	100	90	-	UL	-	
		KU10S35NS	275	100	10/1000	125	450 *2	100	90	-	-	
- - 2F	B9-4	KP20NU11	60	325	10/700	125	100	150	295 *3	-	-	-
		KP40NU11	60	500	10/700	125	100	150	485 *3	-	-	-
		KP40RU22	60	500	10/700	125	195	100	285 *3	-	-	-

*1 : V_{BR} *2 : V_{CL}(max) *3 : typ.  : UL497B recognized (UL File No.E183905)

Varistor

Package		Type No.	Absolute Maximum Ratings			Electrical Characteristics		Halogen free	Automotive
JEDEC Code JEITA Code House Name	Fig.		I _{F(RMS)} [A]	I _{FSM(R.M.S)} [A]	T _J [°C]	V _F [V]	Conditions I _F [mA]		
DO-214AC - 1F	B4-1	VR61F1	0.37(*1)/0.28(*2)	7.5	-55 to 150	2.3 ± 0.25	1	-	-





*1 : On alumina substrate *2 : On glass-epoxy substrate

TVS (Transient Surge Suppressor)

Power Clampers

- Features
 - 1.High speed response.
 - 2.Absorption energy tolerance capacity.
 - 3.Narrow clampingvoltage width.
 - 4.Reverse blocking type.

- Application 1.Snubber circuit in the primary side of switch-mode power supplies.

Package	 7.6 × 4.0 × 2.8(mm)	 5.0 × φ 4.0(mm)	 7.0 × φ 4.4(mm)	
JEDEC Code	—	—	—	
JEITA Code	—	—	—	
House Name	2F	AX078	AX10	
Fig.	B9-3	A4-2	A5-2	
Internal Circuit				
V _{BR} (typ) [V]	82		ST02D-82	ST03D-82
	145	ST02D-140F2	ST02D-140	ST03D-140
	170	ST02D-170F2	ST02D-170	ST03D-170
	200		ST02D-200	ST03D-200
	240			ST03DH-240
	280			★ ST02DH-280
320			★ ST02DH-320	

★ : Under development

Power Clampers

Surface Mount		Type No.	Absolute Maximum Ratings				Electrical Characteristics						Halogen free	Automotive	
Package			PrSM	ZD		Di	Tj	ZD			Di				
JEDEC Code	Fig.			V _{RRM}	V _{R(DC)}			V _{BR} (min)	V _{BR} (max)	Conditions I _R	I _R (max)	I _R (max)			Conditions V _R
—	B9-3	ST02D-140F2	200	120	600	-40 to 150	130	160	1	5	5	600	—	—	
2F		ST02D-170F2	200	145	600	-40 to 150	155	185	1	5	5	600	—	—	

Axial		Type No.	Absolute Maximum Ratings				Electrical Characteristics						Halogen free	Automotive	
Package			PrSM	ZD		Di	Tj	ZD			Di				
JEDEC Code	Fig.			V _{RRM}	V _{R(DC)}			V _{BR} (min)	V _{BR} (max)	Conditions I _R	I _R (max)	I _R (max)			Conditions V _R
— AX078	A4-2	ST02D-82	200	67	600	-40 to 150	74	90	1	5	5	600	—	—	
		ST02D-140	200	120	600	-40 to 150	130	160	1	5	5	600	—	—	
		ST02D-170	200	145	600	-40 to 150	155	185	1	5	5	600	—	—	
		ST02D-200	200	170	600	-40 to 150	185	215	1	5	5	600	—	—	
— AX10	A5-2	ST03D-82	300	67	600	-40 to 150	74	90	1	5	5	600	—	—	
		ST03D-140	300	120	600	-40 to 150	130	160	1	5	5	600	—	—	
		ST03D-170	300	145	600	-40 to 150	155	185	1	5	5	600	—	—	
		ST03D-200	300	170	600	-40 to 150	185	215	1	5	5	600	—	—	
		ST03DH-240	300	200	1000	-40 to 150	220	250	1	5	10	1000	—	—	
		★ ST02DH-280	300	230	1000	-40 to 150	250	300	1	5	10	1000	—	—	
★ ST02DH-320	300	260	1000	-40 to 150	300	350	1	5	10	1000	—	—			

★ : Under development

POWER MODULES

Power Modules include combinations of various power semiconductors.

They are easy to design, reduce the number of components needed in the device, are suitable for device downsizing, and mitigate heat-dissipation concerns.

At Shindengen, a multitude of packages allow us to meet customer needs of MOSFET, diodes, and other products.

Semi customizable support and customizable package design support are available.

Transfer Type Package Sample

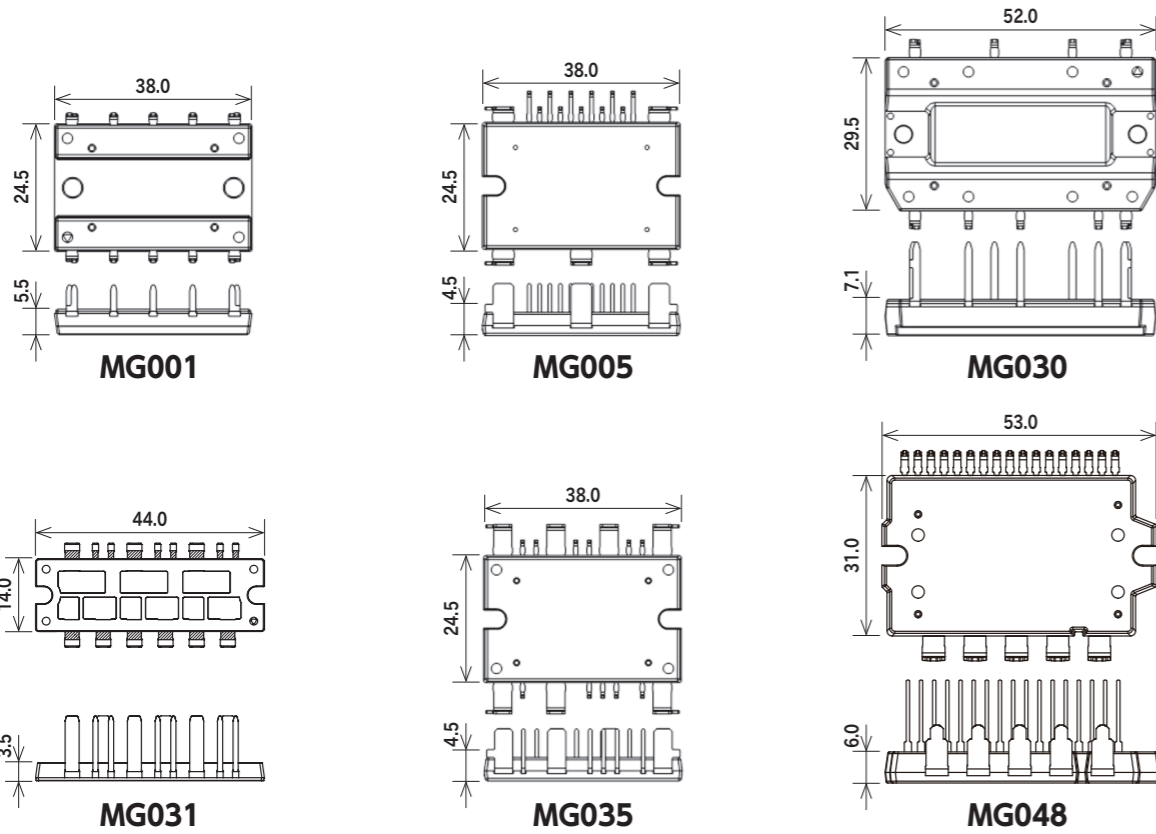

Potting Type Package Sample

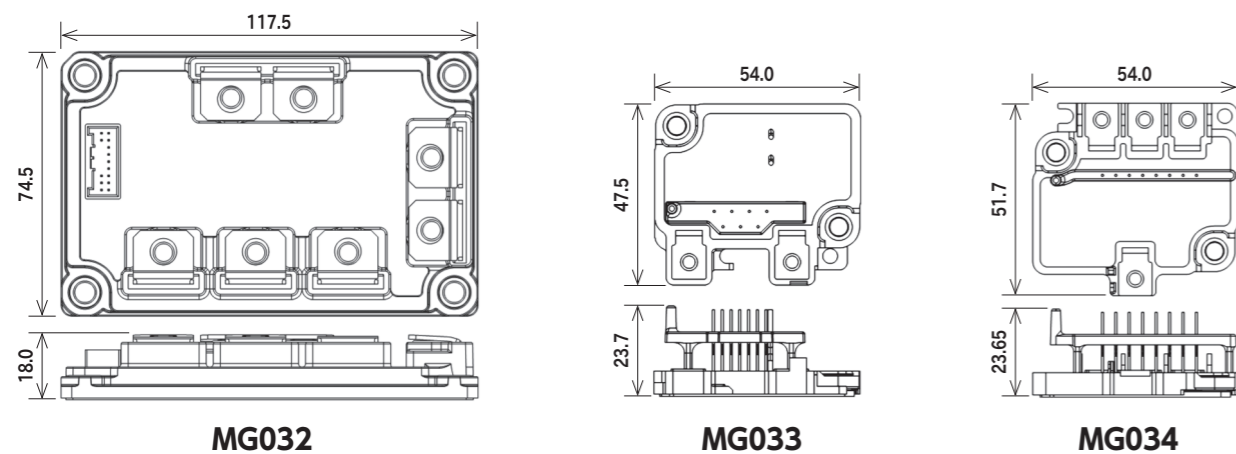

CB Module Series

Converter + Brake Modules

Package	JEDEC Code JEITA Code House Name	Fig.	Type No.	Converter Diode				Brake IGBT				Brake FRD				Halogen free	UL	Automotive			
				Absolute Maximum Ratings		Electric Characteristics		Absolute Maximum Ratings		Electric Characteristics		Absolute Maximum Ratings		Electric Characteristics							
				V _{RRM} [V]	I _F (AV) [A]	Conditions T _C [°C]	V _F (max) [V]	Conditions I _F [A]	V _{CEs} [V]	I _C [A]	V _{CE} (sat) (typ) [V]	Conditions I _C [A]	V _{RRM} [V]	I _F (AV) [A]	Conditions T _C [°C]				V _F (max) [V]	Conditions I _F [A]	t _{rr} (max) [ns]
-	-	F4	MG001AK028060A	600	20	137	1.05	7	600	28	1.70	28	600	3	137	1.65	3	50	○	UL	-
-	-	F4	MG001AL030060A	600	30	136	1.05	10	600	30	1.5	30	600	3	137	1.65	3	50	○	UL	-

■ : New product UL : UL recognized (UL File No. E142422)

Equivalent Circuit Schematic

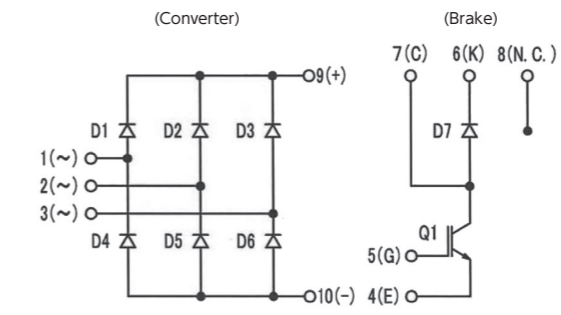

MG001

INV Module Series

Inverter Modules

Package	JEDEC Code JEITA Code House Name	Fig.	Type No.	Absolute Maximum Ratings					Electrical Characteristics						Halogen free	UL	Automotive
				V _{DSS} [V]	I _D [A]	I _{DP} [A]	P _T [W]	T _{ch} [°C]	R _{DS(ON)} (typ) [mΩ]	R _{DS(ON)} (max) [mΩ]	C _{iss} (typ) [pF]	Q _g (typ) [nC]	V _{th} (typ) [V]	R _{th(j-c)} (max) [°C/W]			
-	-	F6	MG032A4207R5A	75	420	840	500	150	-	0.98	80120	505	3.0	0.25	-	-	○
-	-	F6	MG032B420010A	100	420	840	500	150	0.99	1.37	91800	500	3.0	0.25	-	-	○
-	-	F5	MG031B090004A	40	90	360	125	175	2.34	3.2	4180	76	2.0	1.2	○	-	○
-	-	F5	★ MG031E120004A	40	120	480	104	150	2.5	3.1	TBD	TBD	3.0	1.2	○	-	■
-	-	F5	★ MG031G148004A	40	148	592	154	175	1.75	2.2	5330	96	3.0	0.97	○	-	○
-	-	F5	★ MG031L080006A	60	80	320	104	150	4.5	5.6	3390	58	3.0	1.2	○	-	■
-	-	F5	★ MG031N110006A	60	110	440	128	150	3.0	3.8	5430	89	3.0	0.97	○	-	■
-	-	F5	★ MG031MC148004A	40	148	592	128	150	1.75	2.2	5330	96	3.0	0.97	○	-	■
-	-	F5	★ MG031MD110006A	60	110	440	128	150	3.0	3.8	5430	89	3.0	0.97	○	-	■
-	-	F8	★ MG048A150004A	40	150	600	147	150	2.1	2.7	5900	111	3.0	0.85	○	-	■
-	-	F8	★ MG048B100006A	60	100	400	147	150	2.92	3.65	8100	129	3.0	0.85	○	-	■

■ : New product ★ : Under development ■ : Please contact us.

Equivalent Circuit Schematic

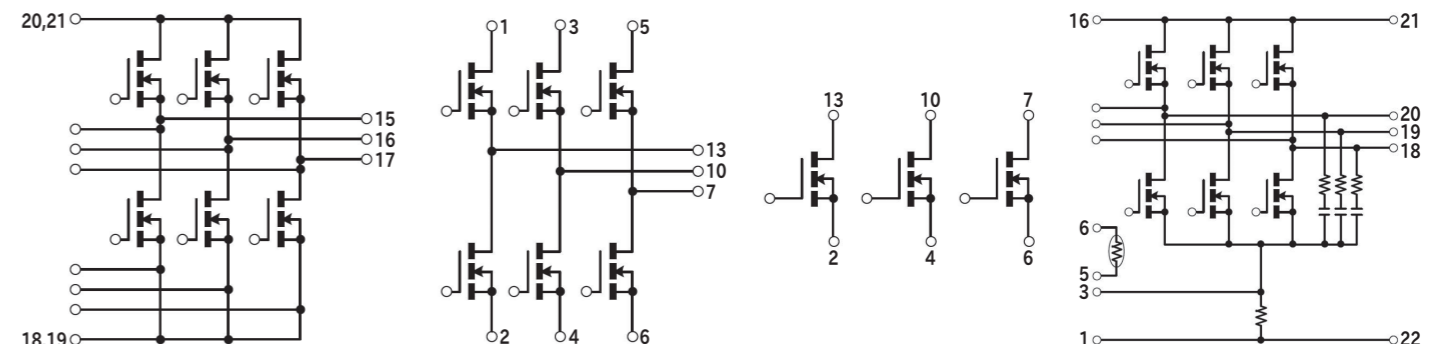

MG032

MG031

MG031
(MG031MC148004A)
(MG031MD110006A)

MG048

POWER ICs

Line up

IC for LED Lighting

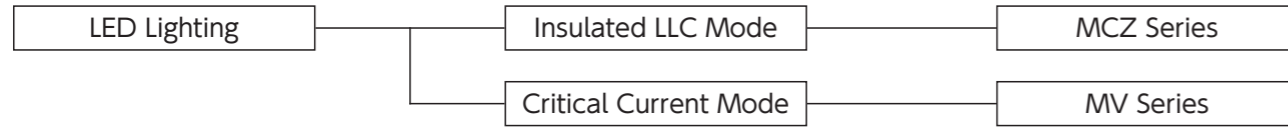

IC for Power Supply

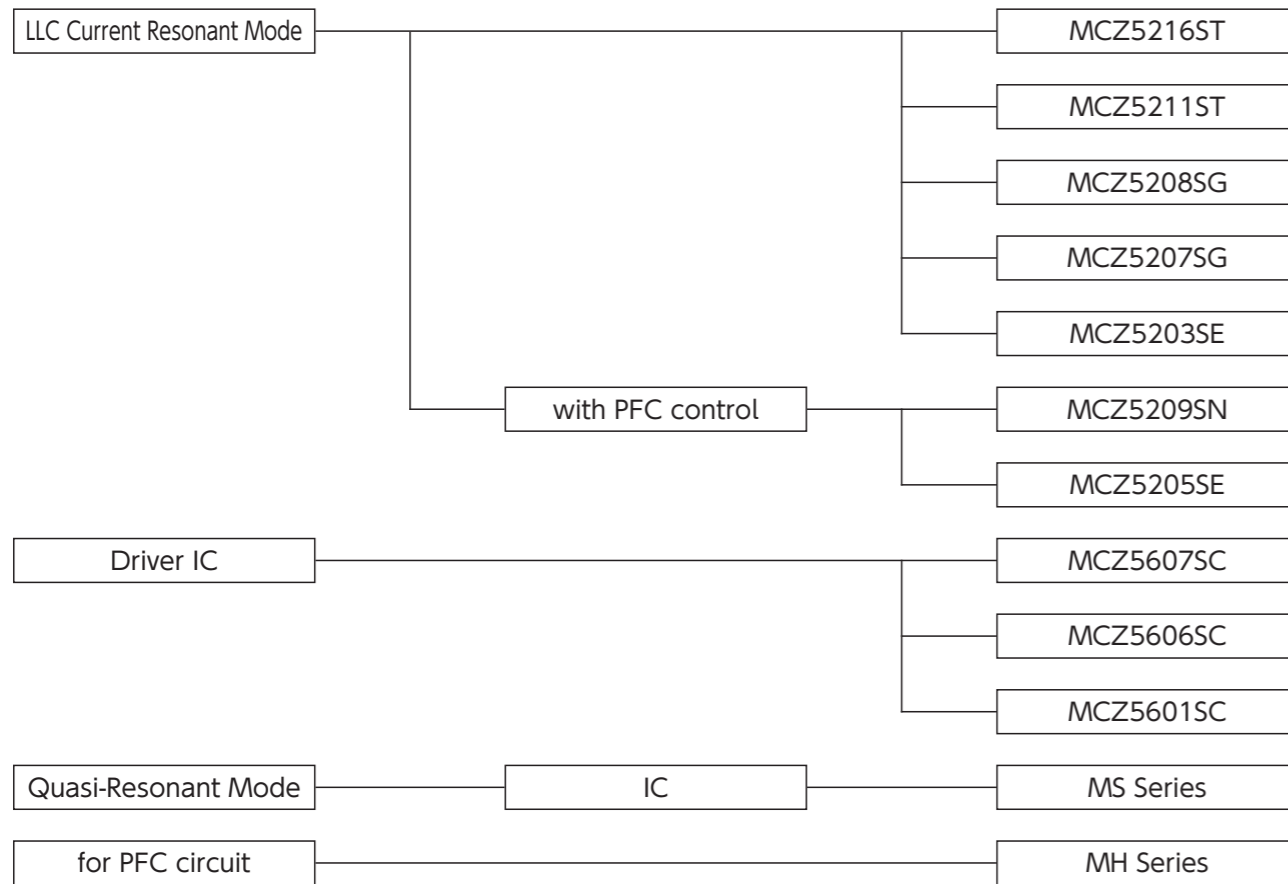

Ideal Diode IC

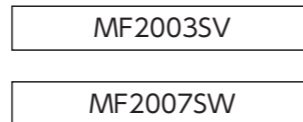



IC for LED Lighting

Current Mode Power Supply ICs for LED Lighting : MV Series

- Outline The MV series has a specialized function for LED lighting with PWM & Linear dimming that operates critical current mode without auxiliary winding. On and off width modulation function allows for smooth deep dimming of 1% or less.

MV Series

Critical Current Mode Power Supply ICs for LED Lighting

Package		Type No.	HV Startup	Vcc [V]	Output	ON/OFF	Built-in Regulator Voltage [V]	Linear Dimming	PWM Dimming	Halogen free	Automotive		
JEDEC Code JEITA Code House Name	Fig.												
	-	SOP8J	L2	MV1001SC	Yes	9 to 16	1ch	-	-	Yes	Yes	-	-
			MV1002SC	No	-							-	
			MV1011SC	Yes	-							-	
			MV1012SC	No	-							-	
	-	SOP16	L5	MV2002SG	No	10 to 16	2ch	Cont. by REF Voltage	3.3	-	-	-	-
			MV2052SG	No	5				-	-			

POWER ICs

IC for Power Supply

LLC Current Resonant Mode Controller ICs for Bridge Converter : MCZ Series

- Outline** The MCZ series is an advanced symmetric LLC current resonant mode controller for bridge converters. Symmetric LLC resonant converter applications are greatly expanding due to their extremely high efficiency and low noise characteristics.

High/Low Side Driver IC

- Outline** A driving IC for MOSFET and IGBT power devices. With built-in high-withstand voltage components, it can be used for a variety of uses such as inverter and power supply, etc.

Low Power Standby Quasi-Resonant Power Supply ICs : MS Series

- Outline** The MS series consumes much less power in standby mode than conventional MR series. The ICs incorporate various functions to make it more user-friendly and easier to design a power supply with fewer external components.

PFC ICs : MH Series





- Outline** The MH series is a PFC circuit control IC which enables multistage interleave. An efficient, high power operation is possible by utilizing a follower IC composed of multistage interleave and a leader IC that can be used alone.

Ideal Diode IC

Ideal Diode IC V-Diode™ MF Series

- Outline** This is an ideal diode IC with a built-in reverse connection and reverse current protection it is used for electronic units with batteries as input sources. By using a built-in or a separate MOSFET to control the IC, it allows reducing the size of the circuit board as well as lowering loss and increasing heat dissipation.

MCZ Series

LLC Current Resonant Mode Controller ICs for Bridge Converter															
Package		Type No.	Type	HV Startup	High-side Drive	Vcc (max) [V]	Vin Sensing	Burst Mode	Maximum Frequency [kHz]	X-cap. discharge	Capacitive Mode Protection	Over Voltage Protection	Over Current Protection	Halogen free	Automotive
JEDEC Code JEITA Code House Name	Fig.														
	-	L6	MCZ5216ST	LLC Current Resonant Mode	Yes	35	Yes	Yes	500	Yes	Yes	Latch	Timer Latch	○	-
	SOP18		MCZ5211ST	LLC Current Resonant Mode	Yes			Yes	500	No				○	-
	-	L8	MCZ5209SN	LLC Current Resonant Mode with PFC Control	Yes			Yes	300	No				○	-
	SOP24		MCZ5207SG	LLC Current Resonant Mode	No			Yes	300	No				-	-
	-	L5	MCZ5208SG	LLC Current Resonant Mode	No			Yes	500	No				○	-
	SOP16		MCZ5205SE	LLC Current Resonant Mode with PFC Control	No			No	300	No				-	-
	-	L7	MCZ5205SE	LLC Current Resonant Mode with PFC Control	No	No	300	No	-	-					
	SOP22		MCZ5203SE	LLC Current Resonant Mode	No	No	300	No	-	-					

■ : New product



High/Low Side Driver ICs

Package		Type No.	Output	High-side Floating Supply Voltage [V]	Vcc (max) [V]	Input/Output Channel	Vcc_UVLO [V]	VBS_UVLO [V]	Source [mA]	Sink [mA]	Halogen free	Automotive	
JEDEC Code JEITA Code House Name	Fig.												
	-	L2	MCZ5607SC	High-side/Low-side	622	22	2/2	8.2 to 8.9	8.2 to 8.9	220	450	Not identified	-
	SOP8J		MCZ5606SC	High-side/Low-side	622	22	2/2	8.2 to 8.9	8.2 to 8.9	220	450	Not identified	-
			MCZ5601SC	High-side/Low-side	600	22	2/2	8.2 to 9.0	7.2 to 8.0	400	400	○	-

■ : New product ★ : Under development

MS Series

Low Power Standby Quasi-Resonant Power Supply ICs

Package		Type No.	Vin [V]	Vcc [V]	Over Voltage Protection	Over Current Protection	Stand-by Operation	Bottom Skip	Halogen free	Automotive
JEDEC Code JEITA Code House Name	Fig.									
	-	L3	95 to 450	11 to 21	Auto restart	Auto restart	Auto Burst Mode	1 skip	-	-
	SOP8/7J						MS1004SH	2 skip	-	-
							MS1003SH	1 skip	-	-
	-	L4	MS1006SK	11 to 24	Vcc Latch	Timer Latch 2sec. (typ)	Auto Burst Mode/S-Stby Mode	2 skip	-	-
	SOP14						MS1005SK	Auto Burst Mode/UT-Stby Mode	1 skip	-

★ : Under development



MH Series

PFC ICs

Package		Type No.	Type	Operation Mode	Vin Sensing	Vcc [V]	Zero Current Detection	Diodes Short Protection	FB Open Short Protection	Over Voltage Protection	Halogen free	Automotive
JEDEC Code JEITA Code House Name	Fig.											
	-	L2	MH2501SC	Critical Current Mode	Leader	13 to 23	Auxiliary Winding	Yes	Yes	Yes	-	-
	SOP8J		MH2511SC	Synchronizes with Leader IC	Follower		Unnecessary	-	No	No	No	-











MF Series

Ideal Diode IC

Package		Type No.	Featured Type	Operating Voltage [V]	Reverse Connection Protection	Reverse Current Prevention	Ron (typ.) [mΩ]	Quiescent Current/Shutdown Supply Current	Halogen free	Automotive
JEDEC Code JEITA Code House Name	Fig.									
	-	L9	Built-in Pch MOSFET	2.5 to 40	Yes	Yes	57	Quiescent Current = 3μA	Not identified	○
	WSOP8							MF2007SW	Driver IC for Separate Nch MOSFET	3.5 to 70
	-	L10	Driver IC for Separate Nch MOSFET	3.5 to 70	Yes	Yes	-	Shutdown Supply Current = 10μA	Not identified	○

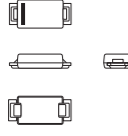
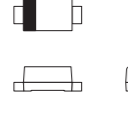
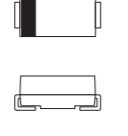
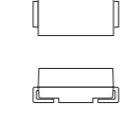
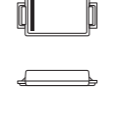
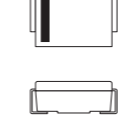
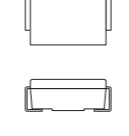
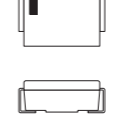
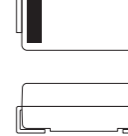
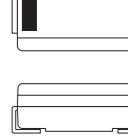
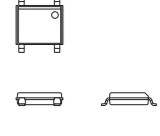
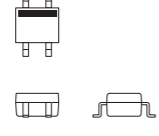
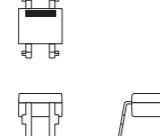
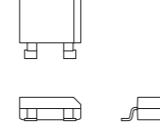
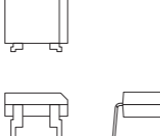
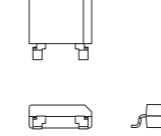
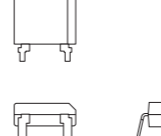
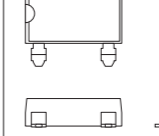
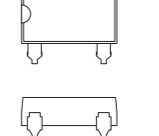
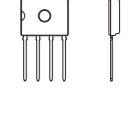
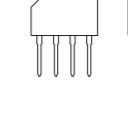
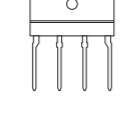
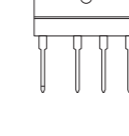
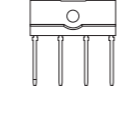
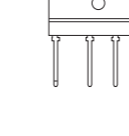
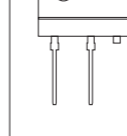
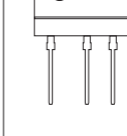
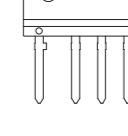
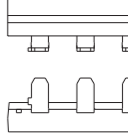
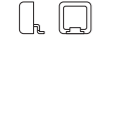
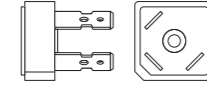
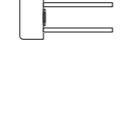
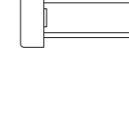
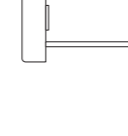
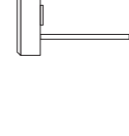
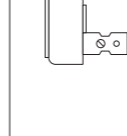
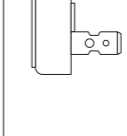
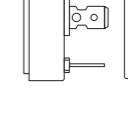
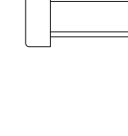
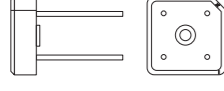
★ : Under development

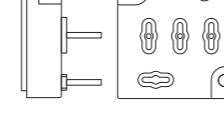
PACKAGE LIST

	1	2	3	4	5	6	7	8	9	10	
A	A1 Package:AX057 	A2 Package:AX06 	A3 Package:AX06 	A4 Package:AX078 	A5 Package:AX10 		A6 Package:AX10 	A7 Package:AX14 			
B	B1 Package:DO-219AB similar G1E 	B2 Package:DO-219AA M1E 	B3 Package:DO-214AC 1E 	B4 Package:DO-214AC 1E 	B5 Package:SC-110B CE 		B6 Package:DO-214AA similar M2E 	B7 Package:DO-214AA similar M2E 	B8 Package:DO-214AA similar M2E 	B9 Package:2F 	B10 Package:2F 
C	C1 Package:SOPA-4 	C2 Package:TO-269AA 1Z(SMD) 	C3 Package:1Z(DIP) 	C4 Package:1N(SMD) 	C5 Package:1N(DIP) 		C6 Package:1NA(SMD) 	C7 Package:1NA(DIP) 	C8 Package:1W(SMD) 	C9 Package:1W(DIP) 	
D	D1 Package:D3K 	D2 Package:2S 	D3 Package:3S 	D4 Package:5S 	D5 Package:JB 		D6 Package:JA 	D7 Package:TSB(4pin),JC(4pin) 	D8 Package:TSB(5pin),JC(5pin) 	D9 Package:JF 	D10 Package:JH 
E	E1 Package:MCP 	E2 Package:D30VC 	E3 Package:S2VB 	E4 Package:S4VB 	E5 Package:S5VB 		E6 Package:S10VB 	E7 Package:S15VB 	E8 Package:S25VB 	E9 Package:S50VB 	E10 Package:S3WB 
	11	12	13	14	15						
E	E11 Package:S10WB 	E12 Package:S15WB 	E13 Package:S20WB 	E14 Package:SVTA 	E15 Package:SVT 						

PACKAGE LIST

	1	2	3	4	5	6	7	8	9	10
F	F1 Package:Module 	F2 Package:Module 	F3 Package:Module 	F4 Package:MG001 	F5 Package:MG031 	F6 Package:MG032 	F7 Package:MG038 	F8 Package:MG048 	F9 Package:MG060 	F10 Package:MG061
G	G1 Package:SC-63 E-pack 	G2 Package:TO-252AA EB 	G3 Package:TO-252AB similar EB 	G4 Package:DO-277A similar EY 	G5 Package:TO-252AA similar EB 	G6 Package:LA 	G7 Package:MO-235B similar LE 			
H	H1 Package:SC-83 similar ETO-220 	H2 Package:SC-83 similar EB 	H3 Package:TO-263AB-1 EB 	H4 Package:TO-263AB EB 	H5 Package:SC-83 similar EB 	H6 Package:TO-263AB EZ 	H7 Package:TO-263-SC EZ-7P 			
J	J1 Package:SC-91A ETO-220(2pin) 	J2 Package:SC-91 ETO-220A(2pin) 	J3 Package:SC-91 ETO-220AG(2pin) 	J4 Package:SC-91 ETO-220G(2pin) 	J5 Package:TO-220AB EA 	J6 Package:SC-91A ETO-220(3pin) 	J7 Package:SC-91 ETO-220A(3pin) 	J8 Package:SC-91 ETO-220AG(3pin) 	J9 Package:SC-91 ETO-220G(3pin) 	
K	K1 Package:SC-93 ITO-3P(2pin) 	K2 Package:TO-247AD MTO-3PT(2pin) 	K3 Package:SC-93 ITO-3P(3pin) 	K4 Package:TO-247AD MTO-3PT(2pin) 	K5 Package:TO-247AD MTO-3PT(3pin) 	K6 Package:TO-247AD MTO-3PV 	K7 Package:TO-247AD MTO-3PV 			
L	L1 Package:SOP8 	L2 Package:SOP8J 	L3 Package:SOP8/7J 	L4 Package:SOP14 	L5 Package:SOP16 	L6 Package:SOP18 	L7 Package:SOP22 	L8 Package:SOP24 	L9 Package:WSON8 	L10 Package:TSSOP10

OUTLINE DIMENSIONS

[Unit:mm]

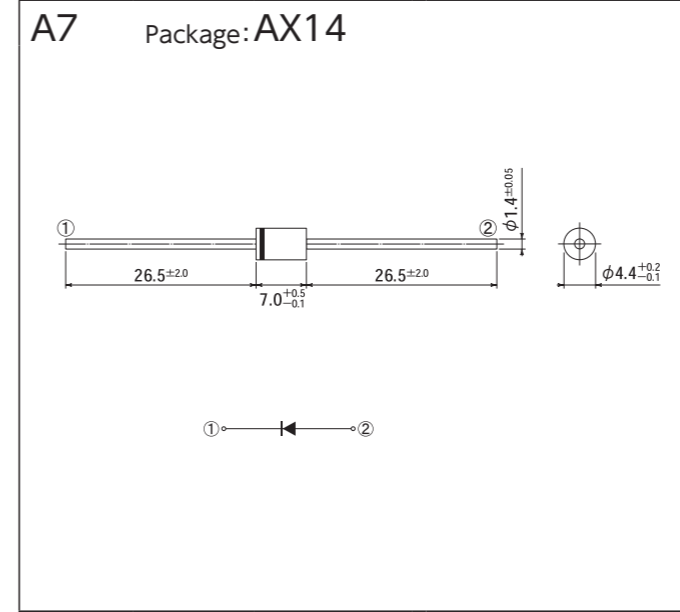
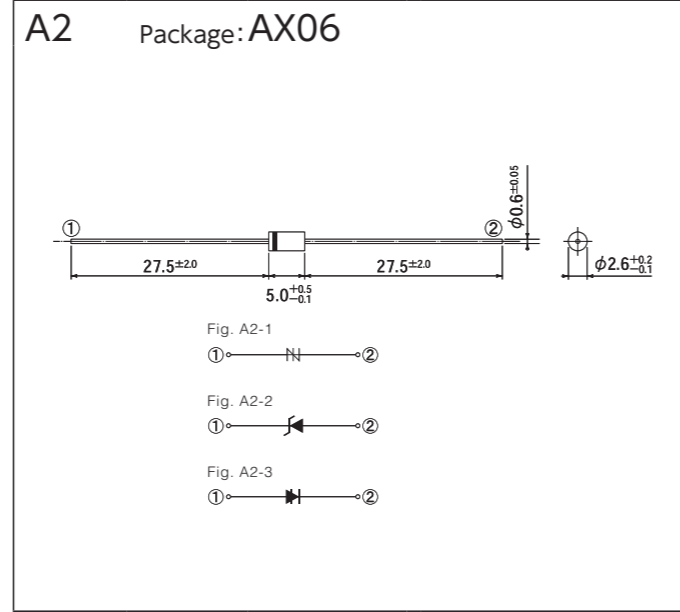
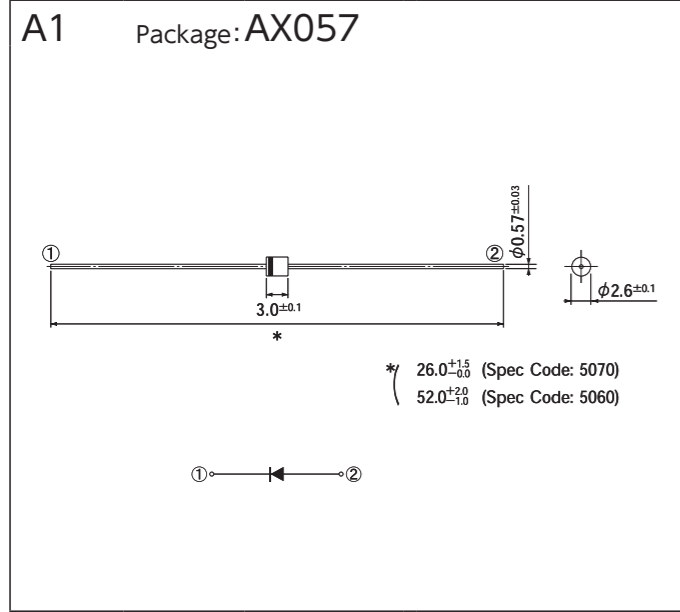

[Unit:mm]

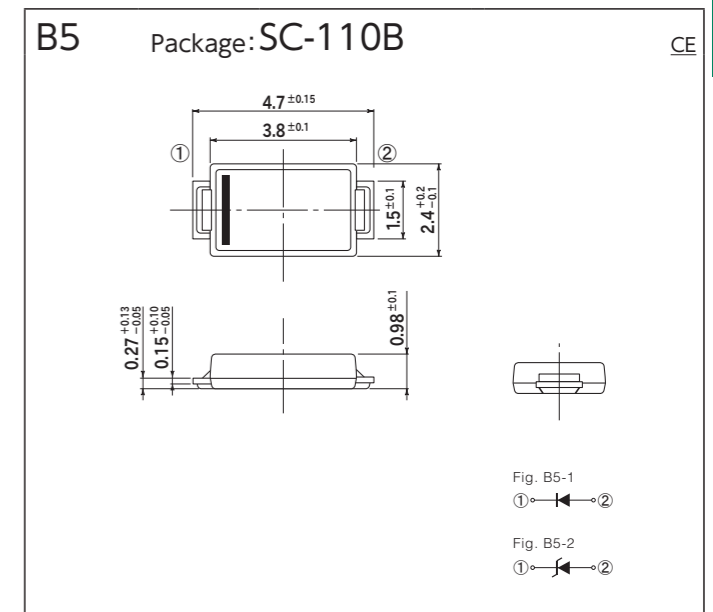
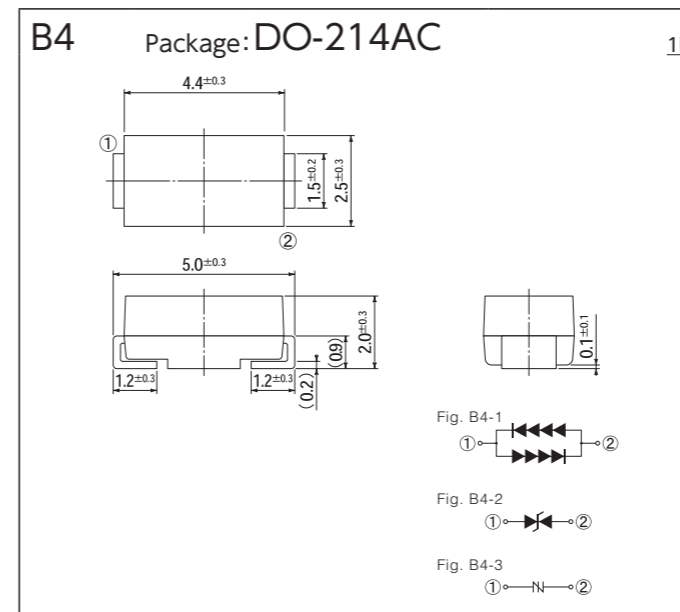
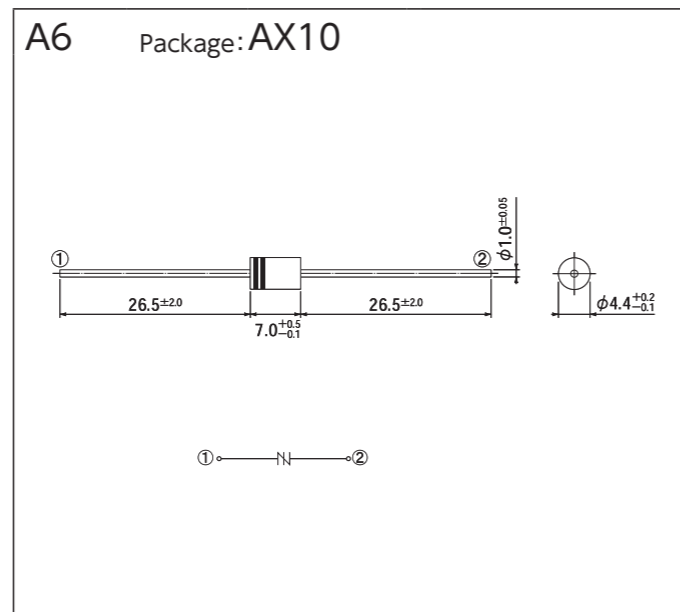
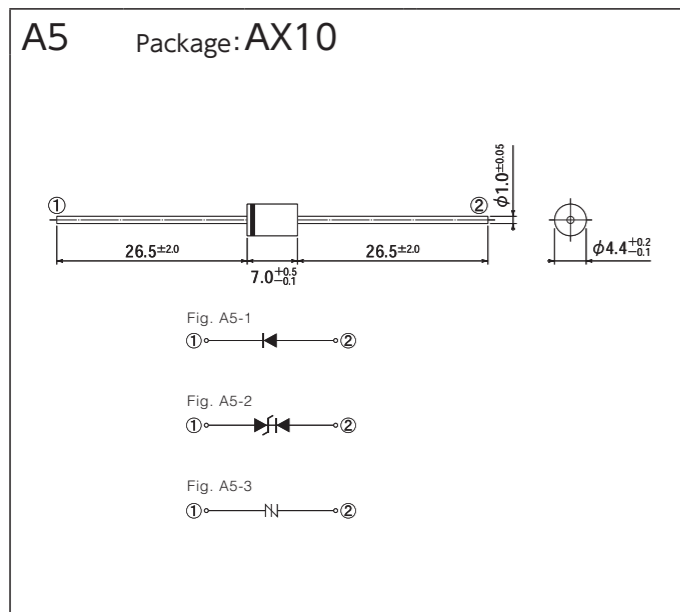
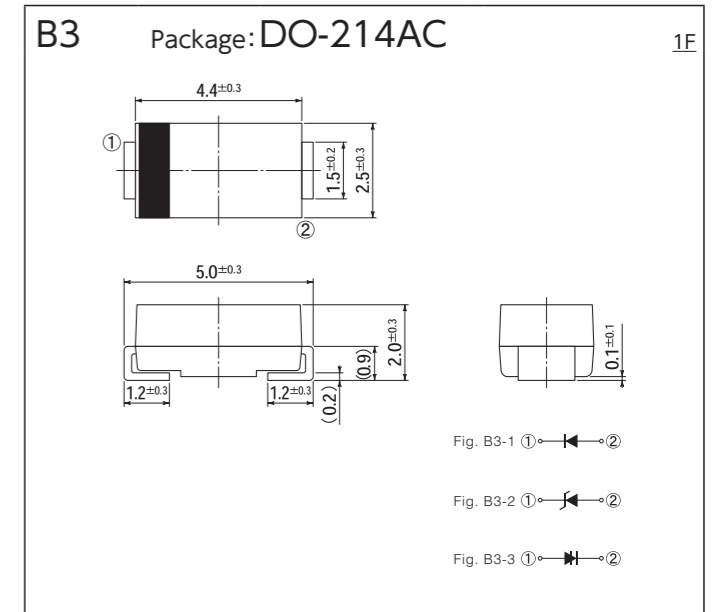
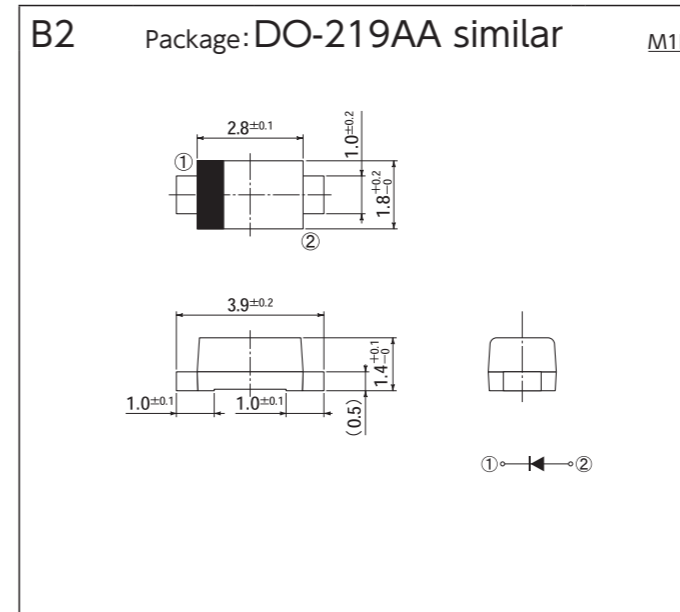
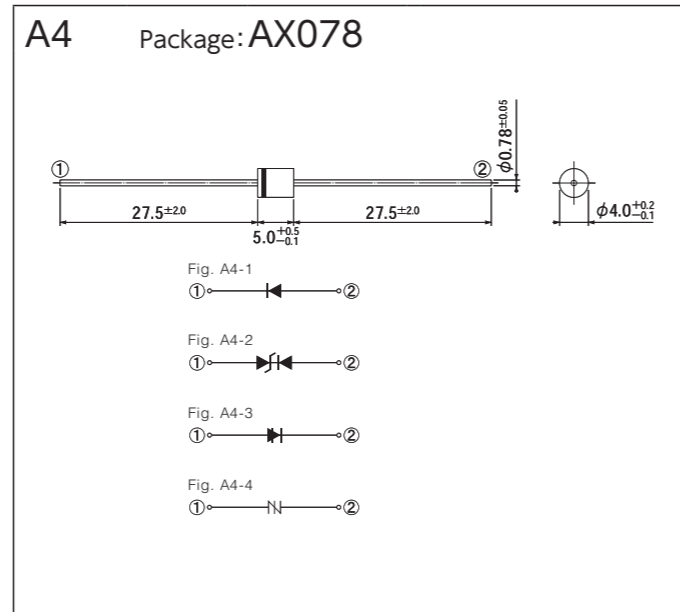
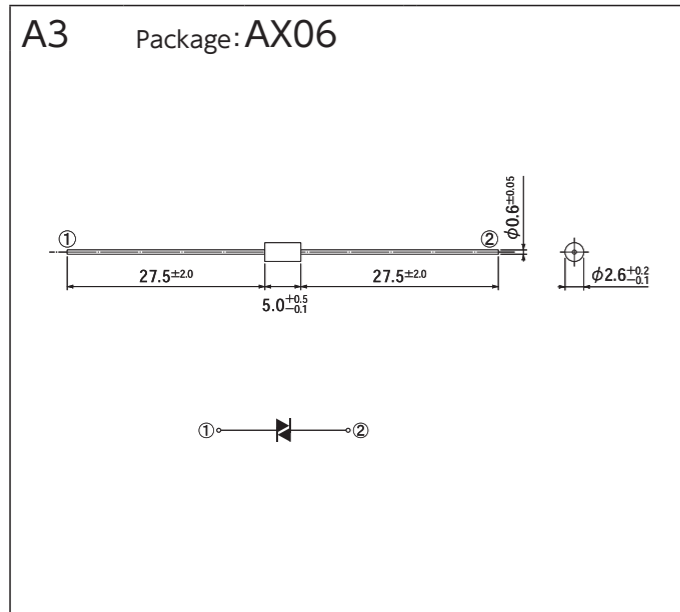
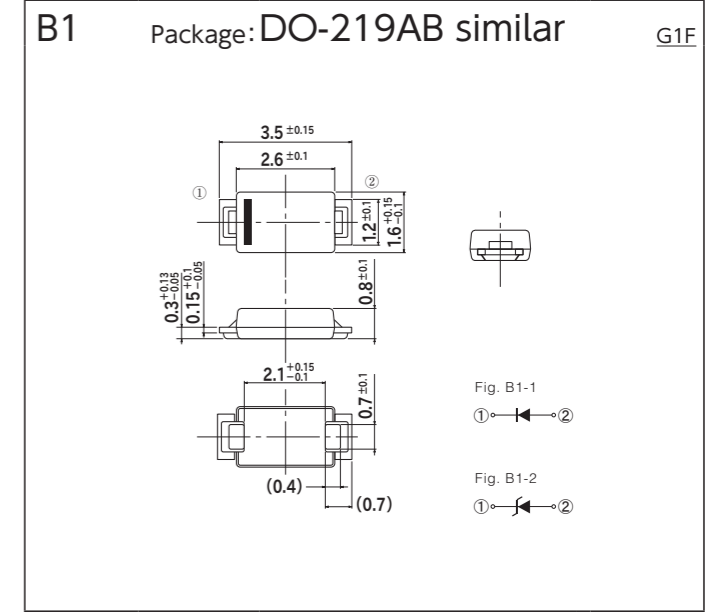

OUTLINE DIMENSIONS

OUTLINE DIMENSIONS

[Unit:mm]

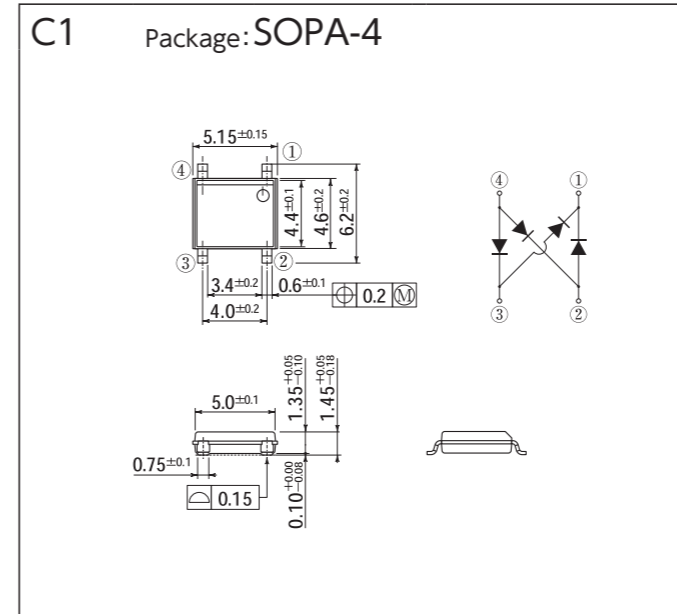
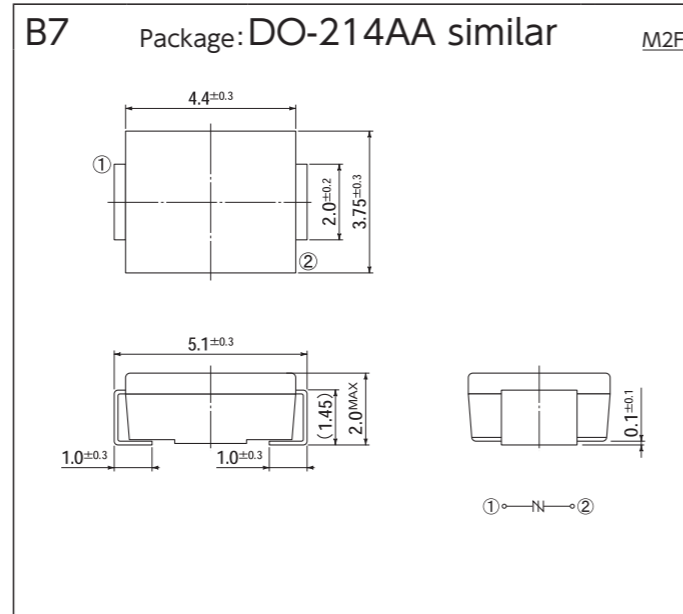
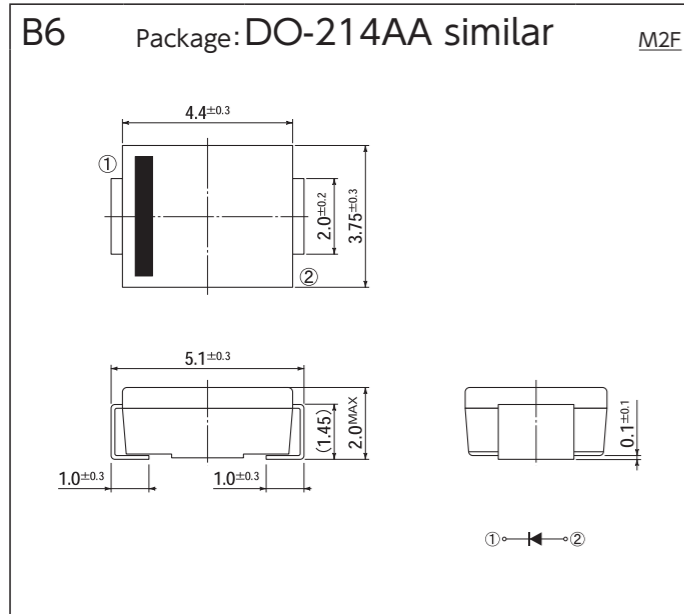

[Unit:mm]

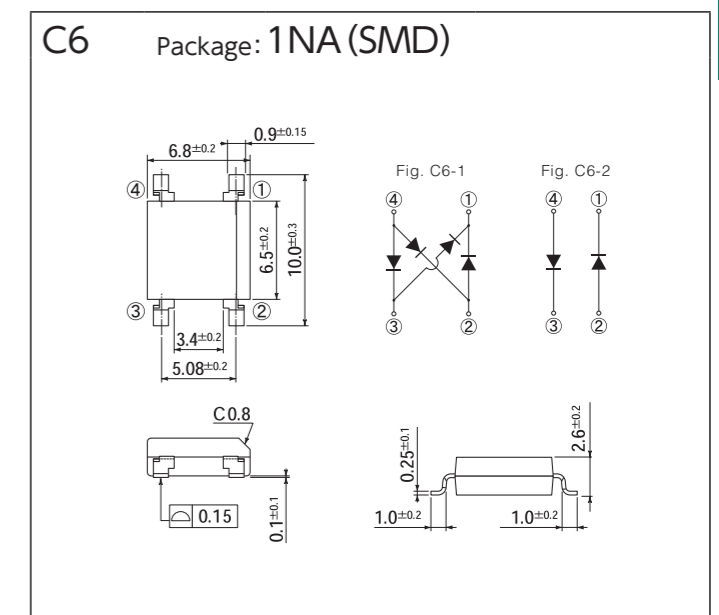
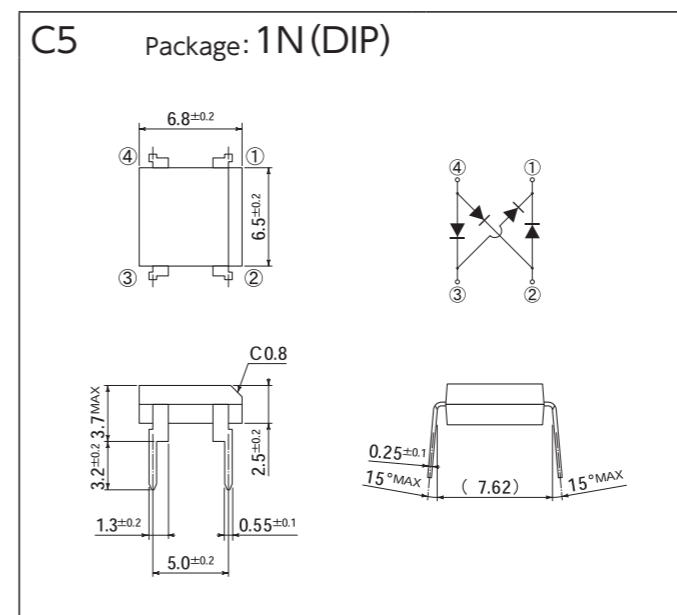
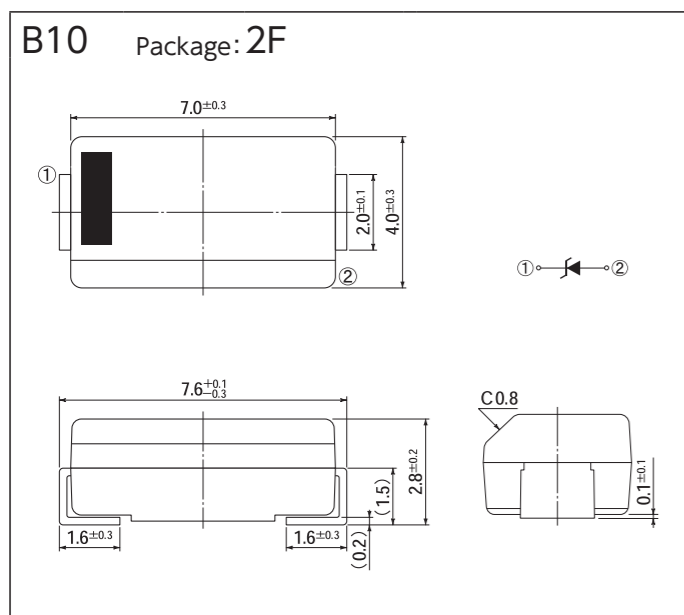
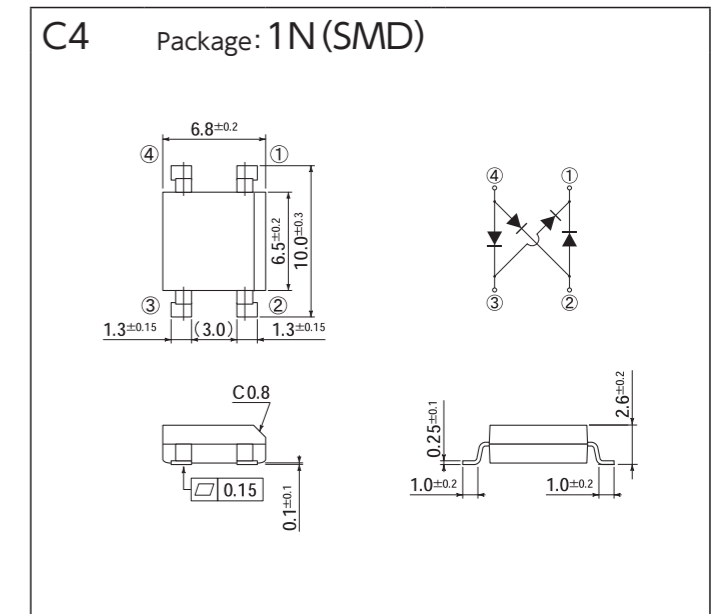
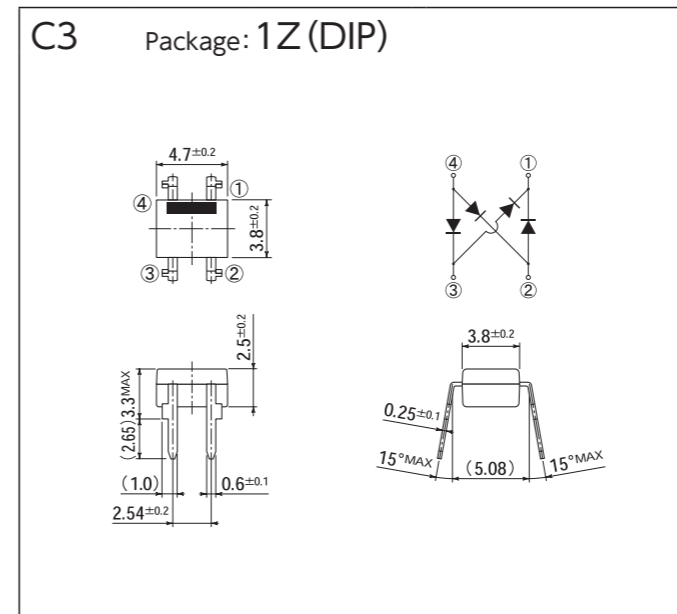
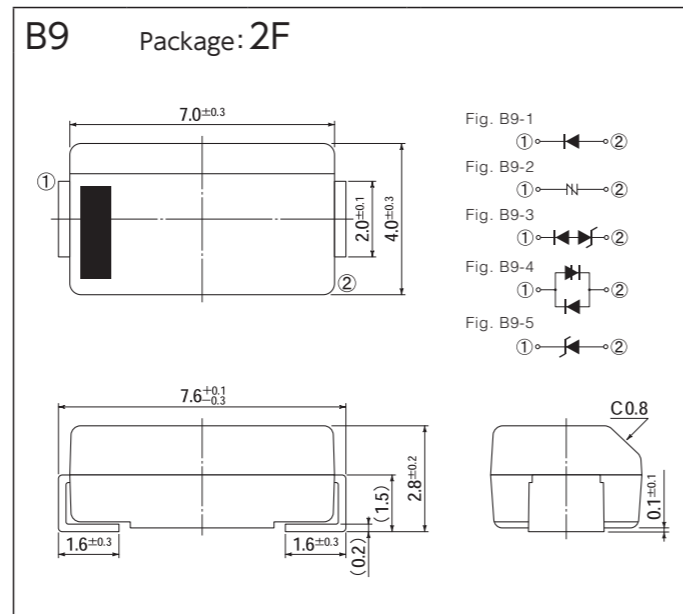
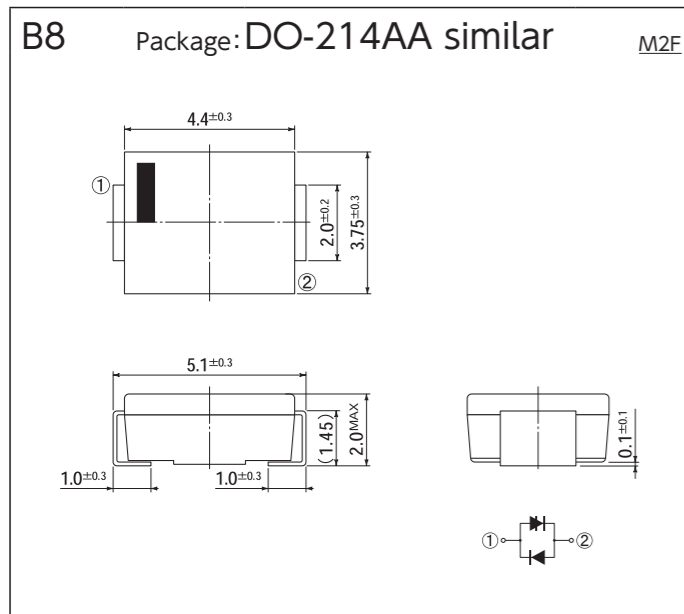
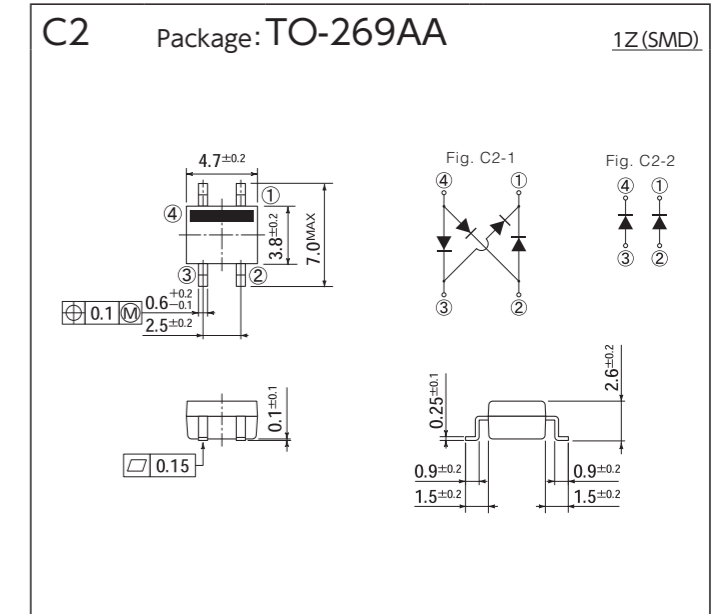

OUTLINE DIMENSIONS

[Unit:mm]

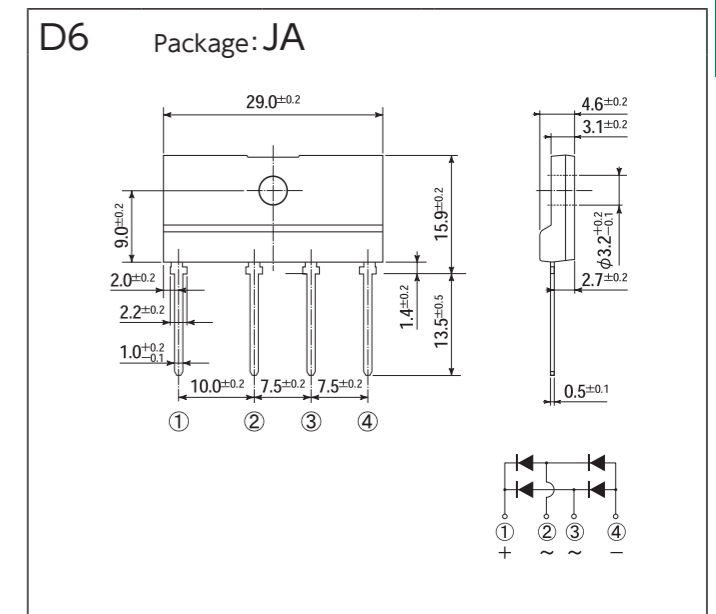
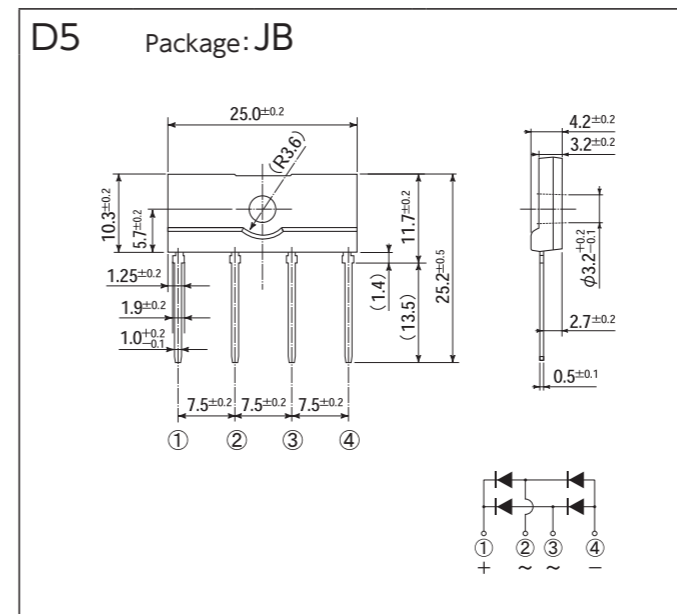
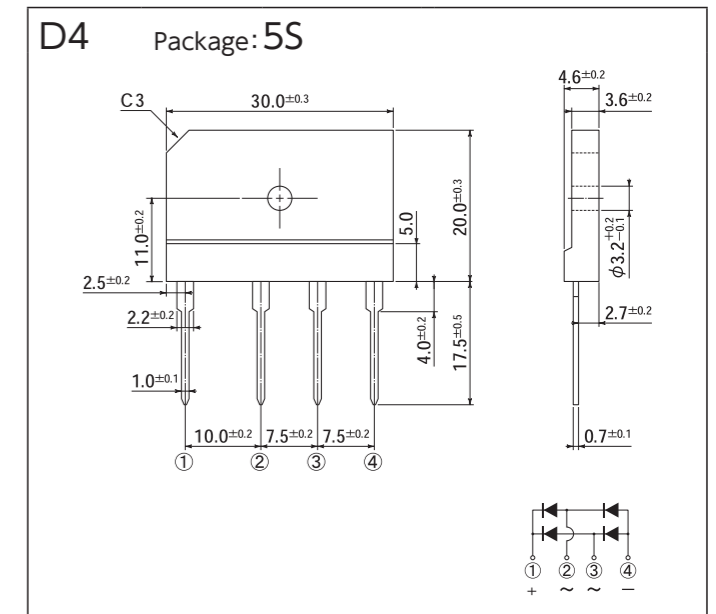
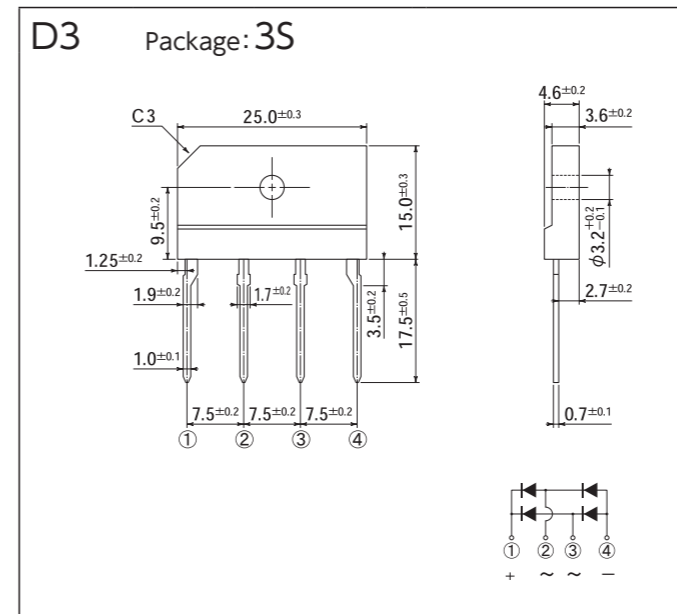
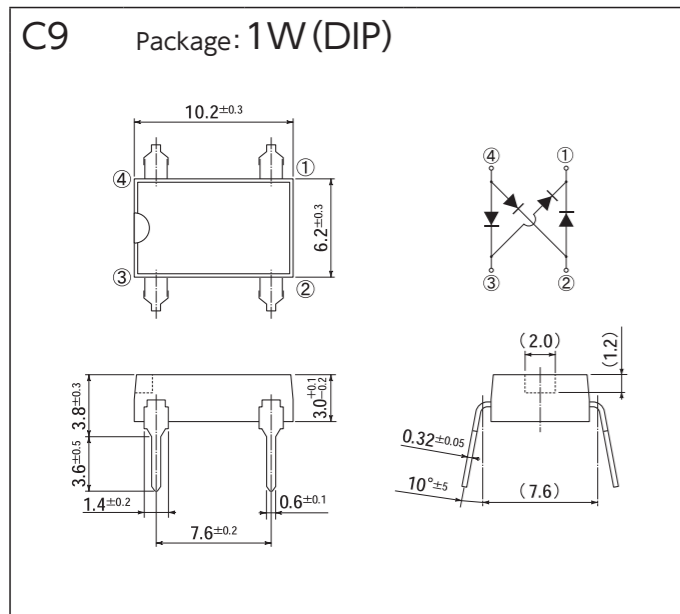
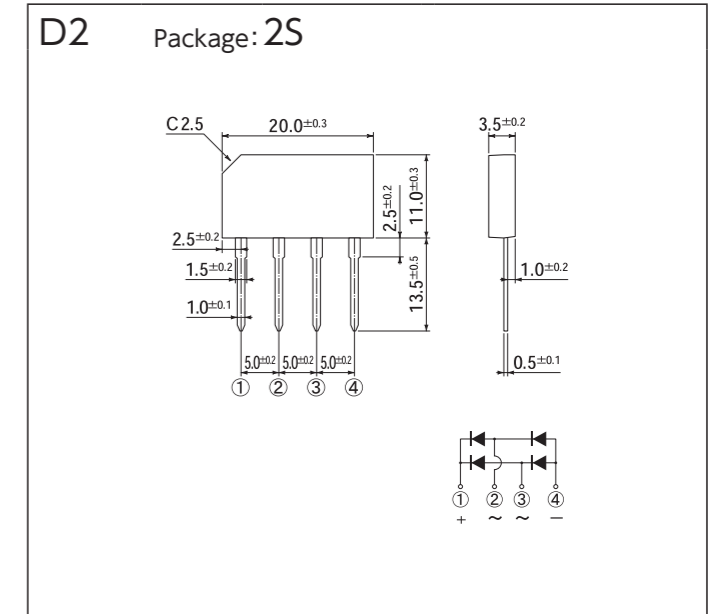
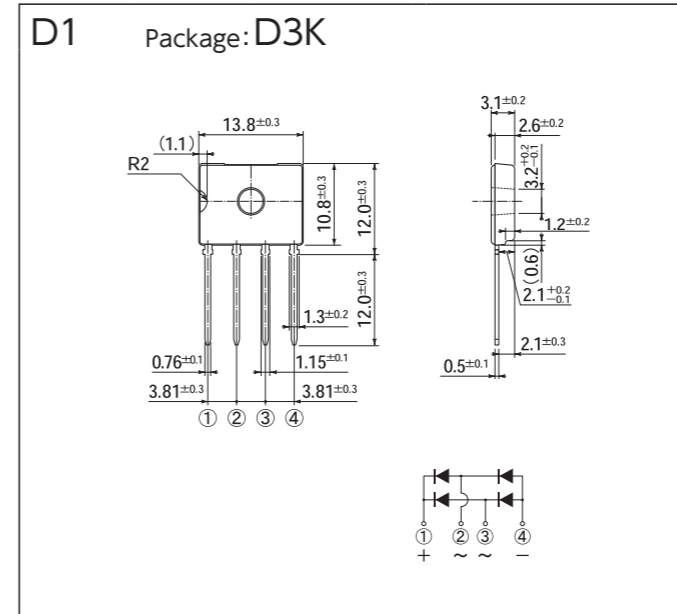
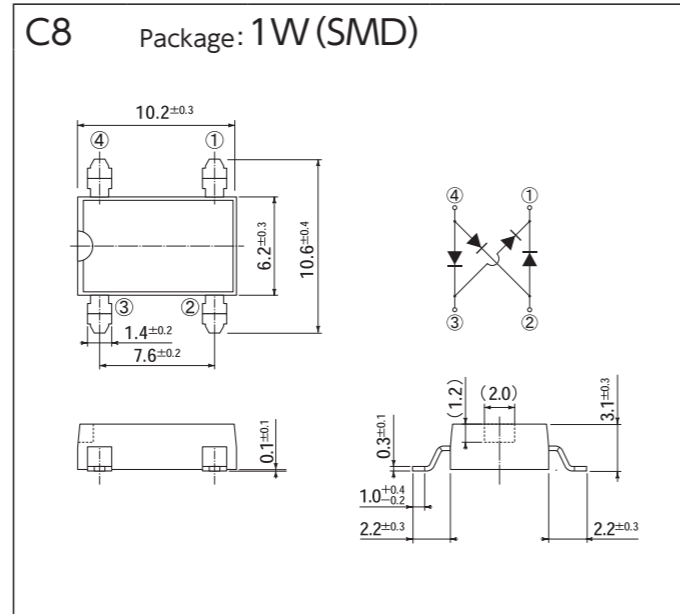
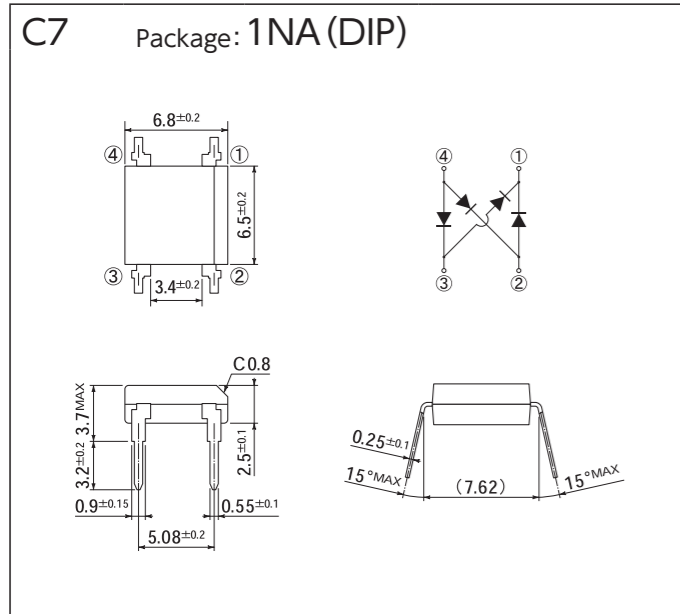

OUTLINE DIMENSIONS

[Unit:mm]

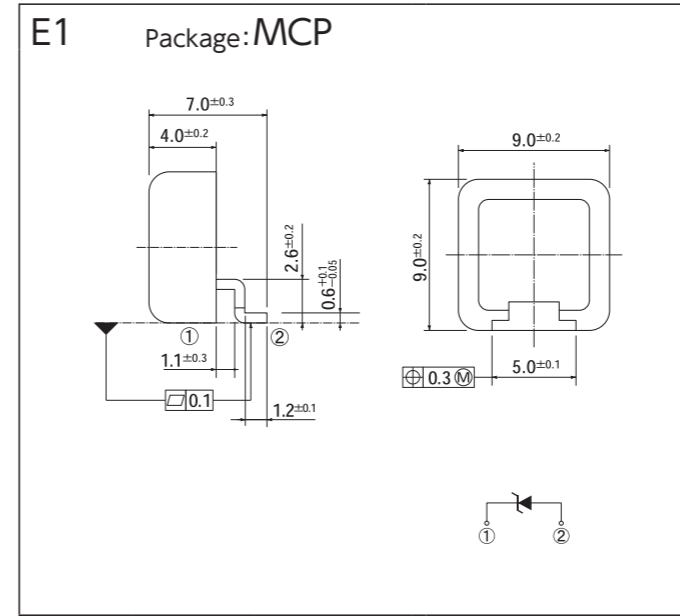
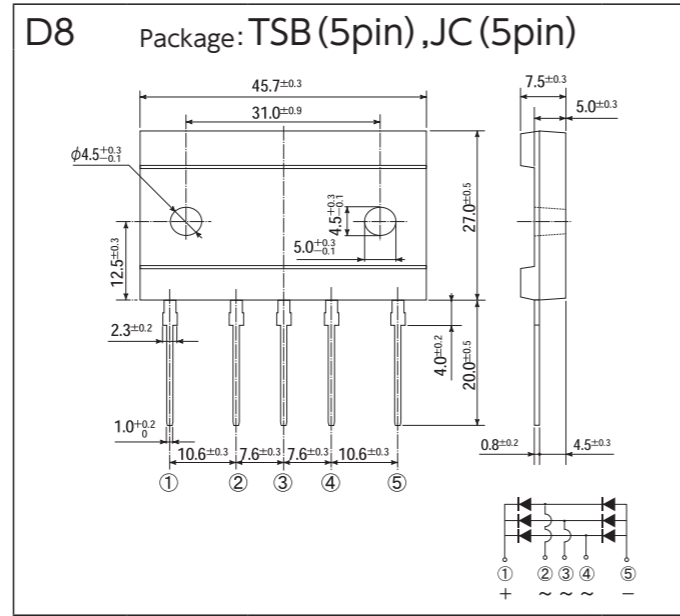
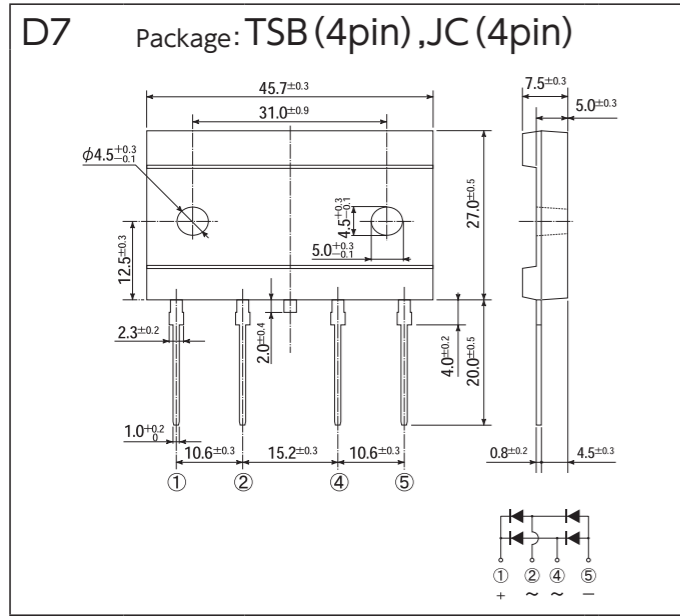

[Unit:mm]

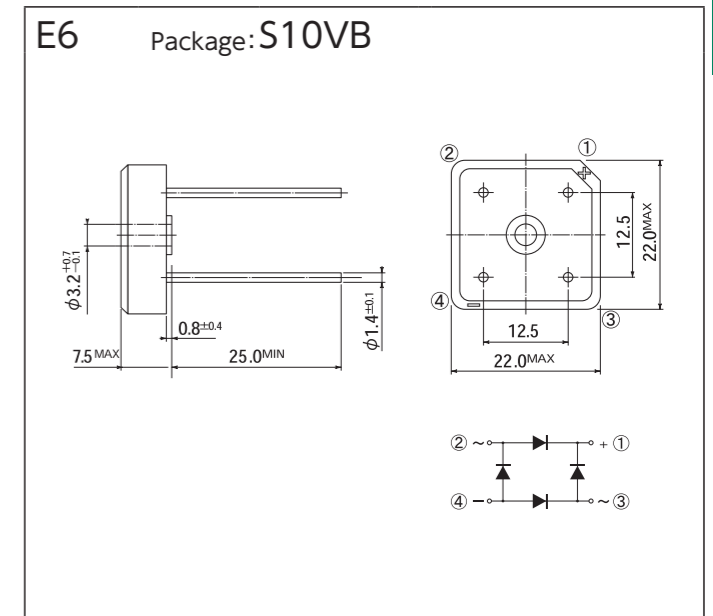
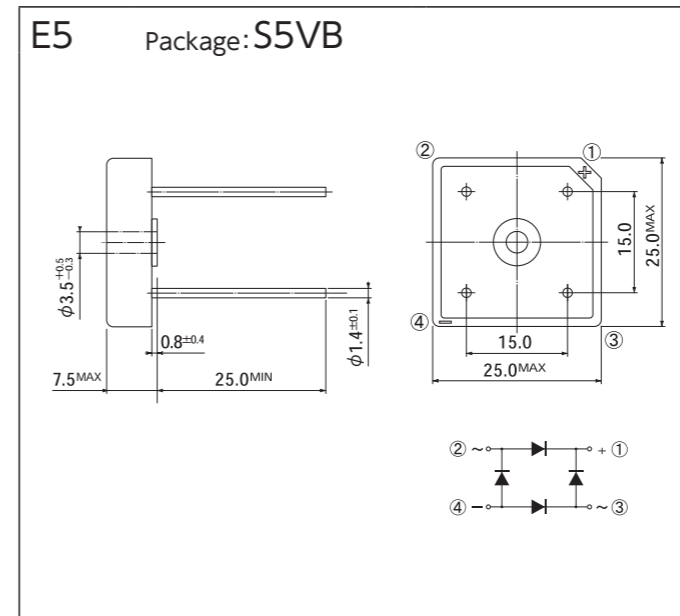
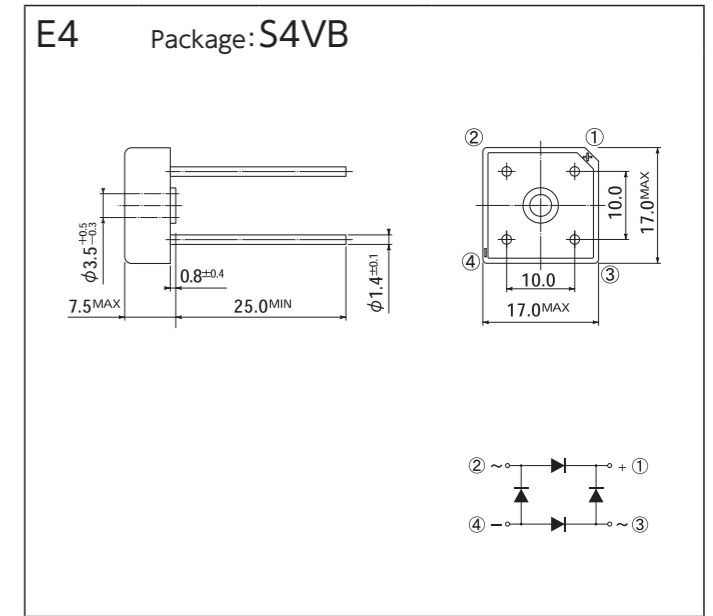
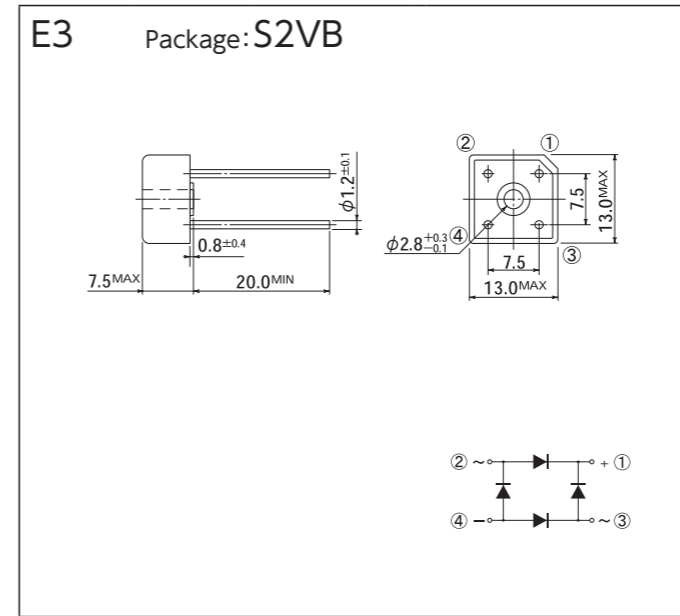
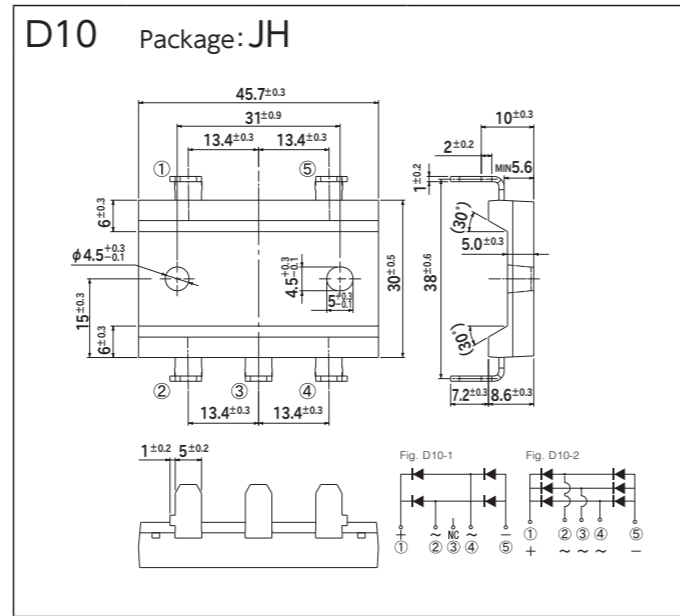
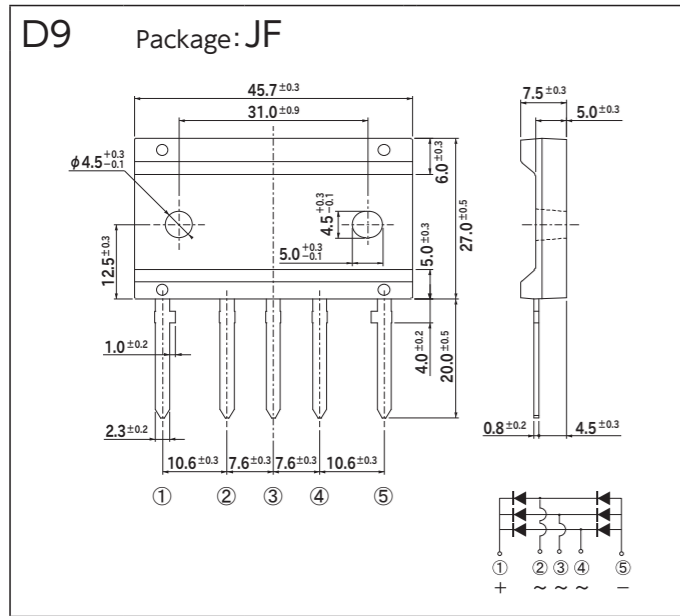
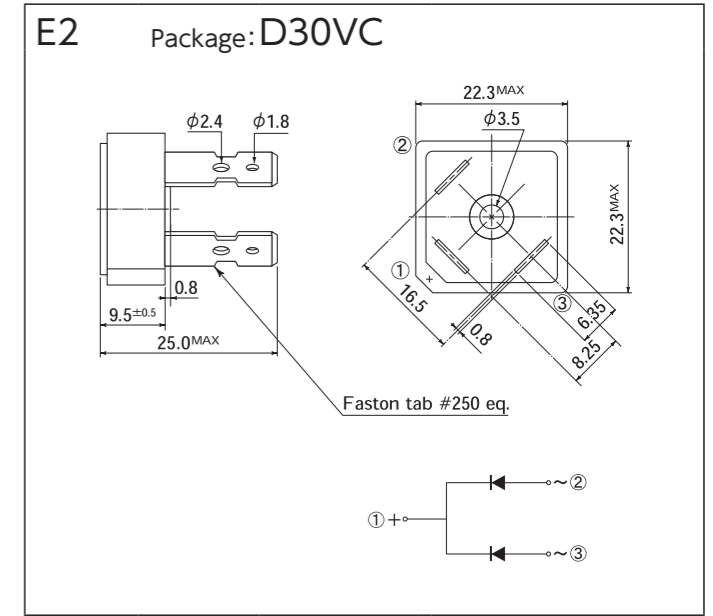

OUTLINE DIMENSIONS

OUTLINE DIMENSIONS

[Unit:mm]

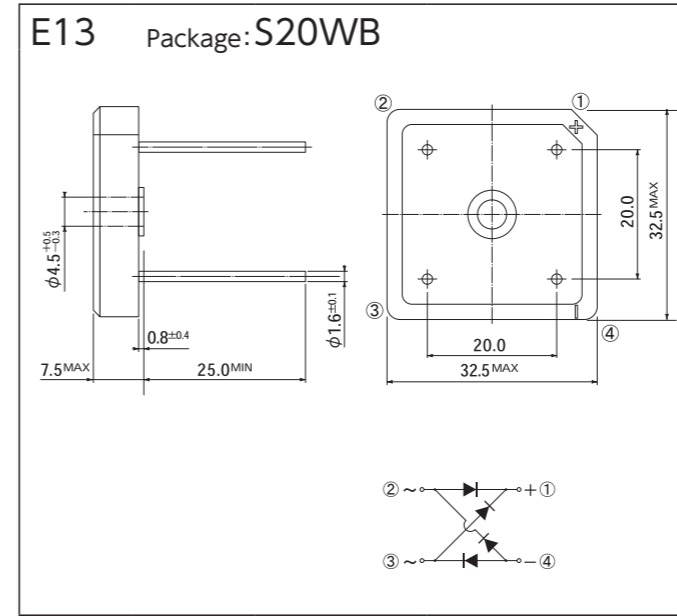
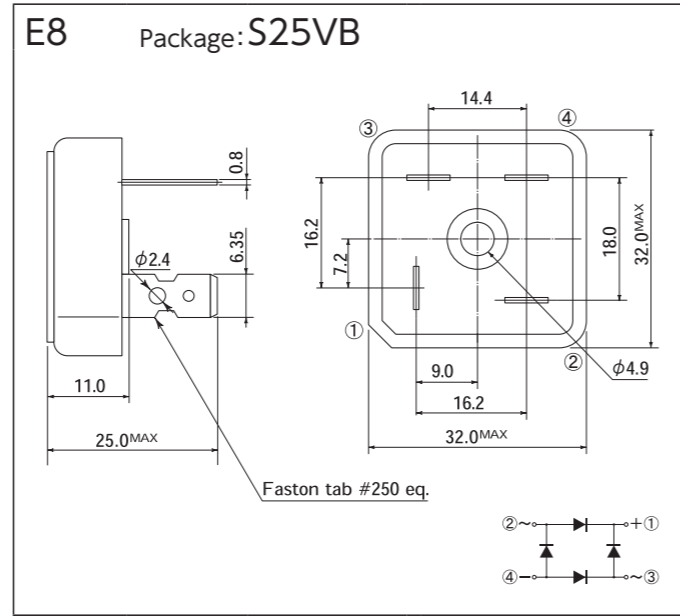
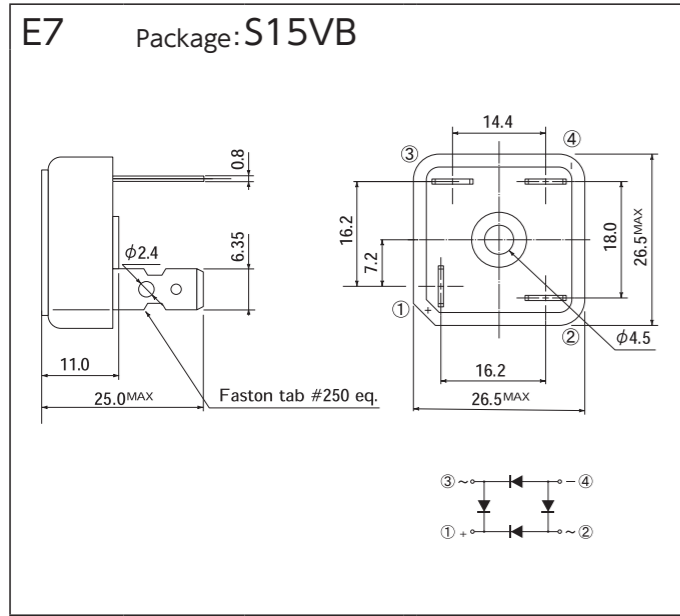

[Unit:mm]

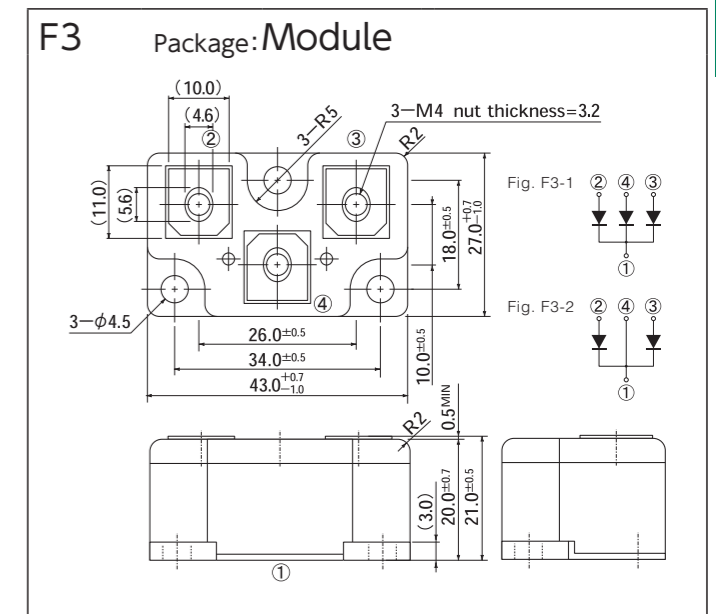
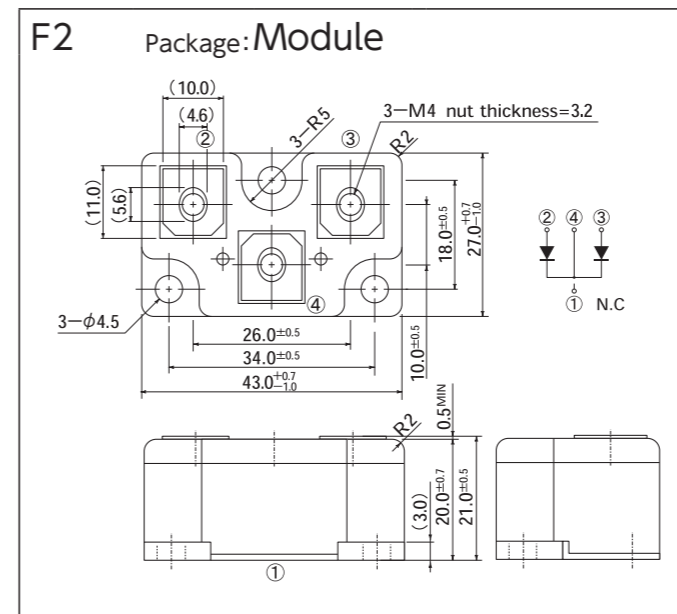
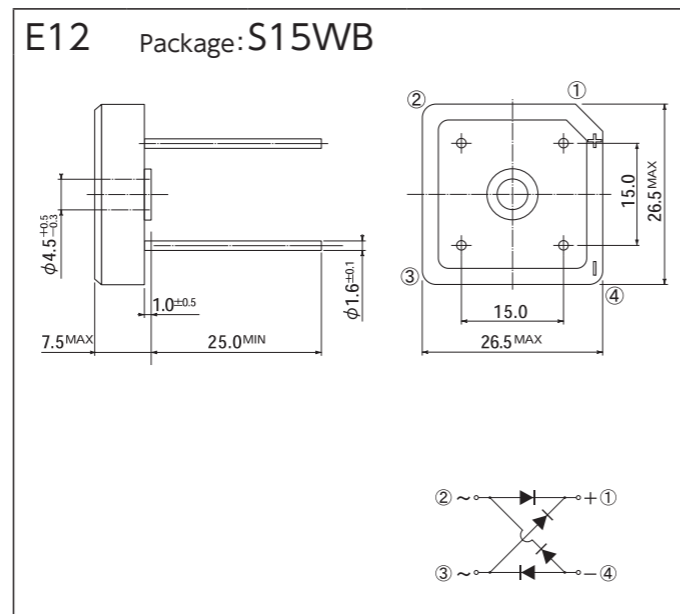
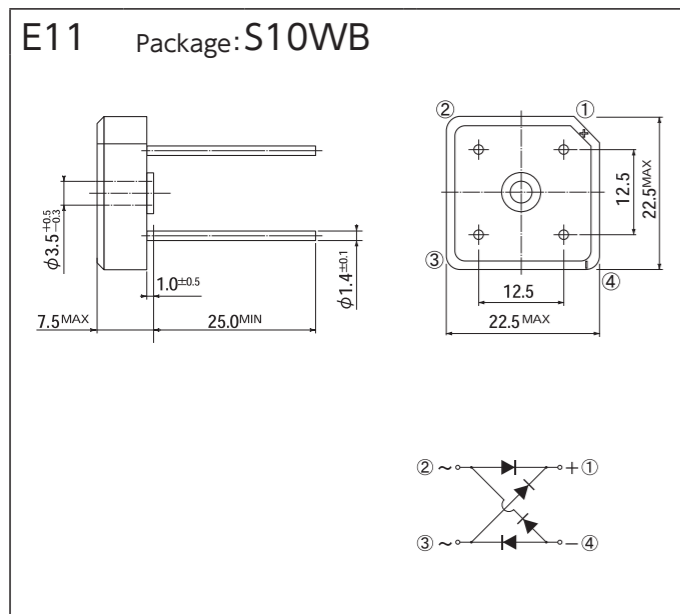
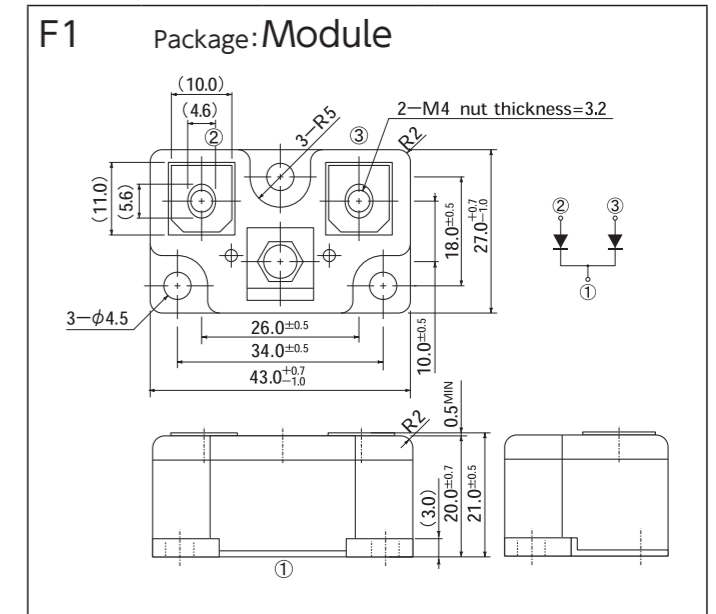
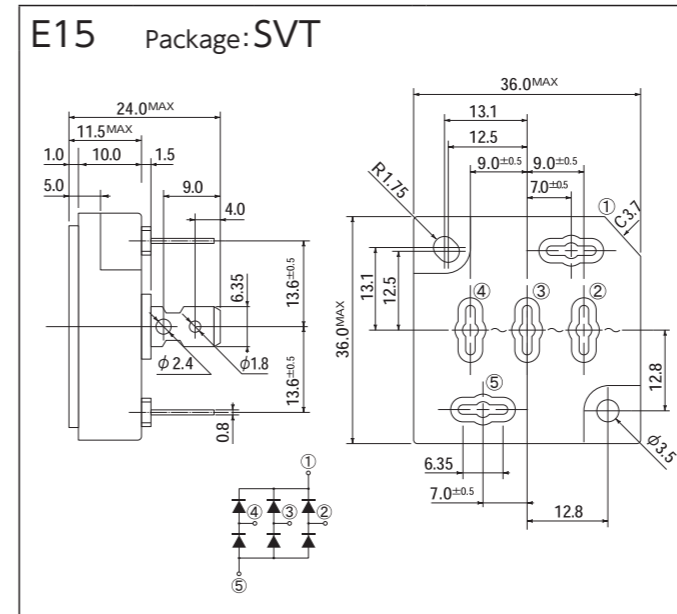
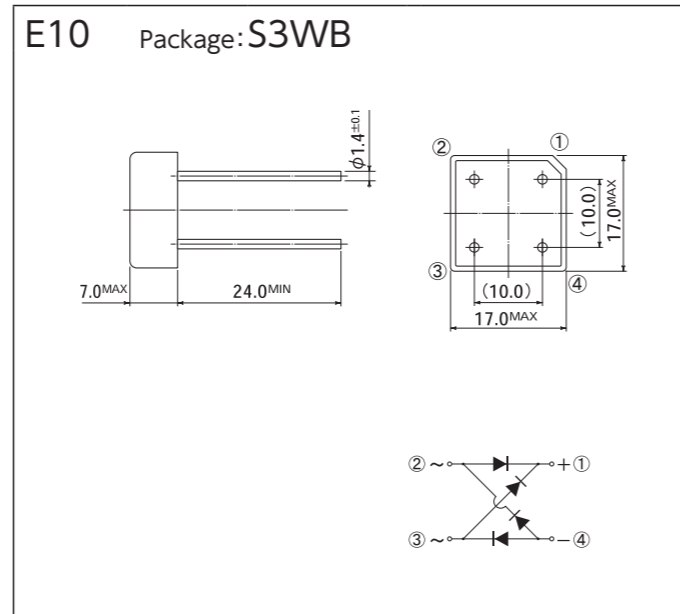
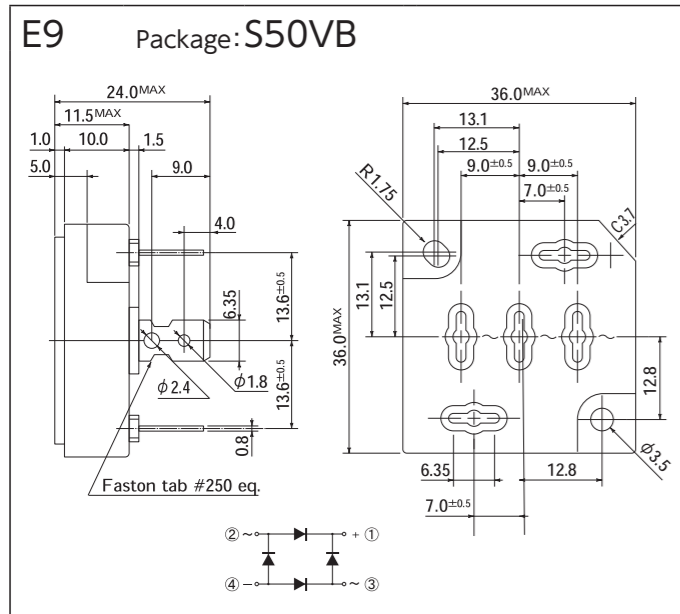
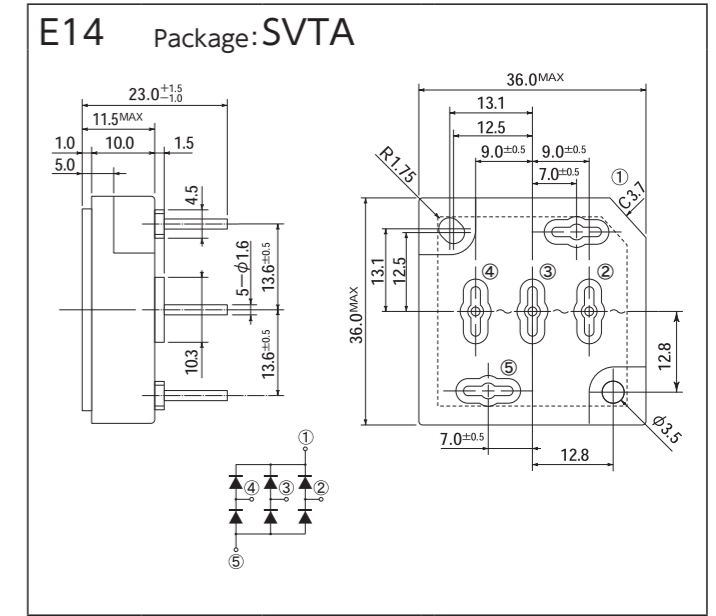

OUTLINE DIMENSIONS

[Unit:mm]

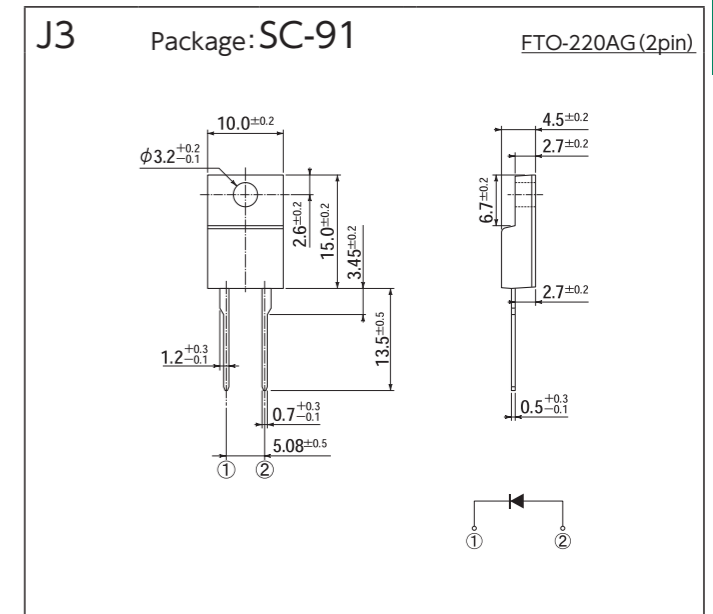
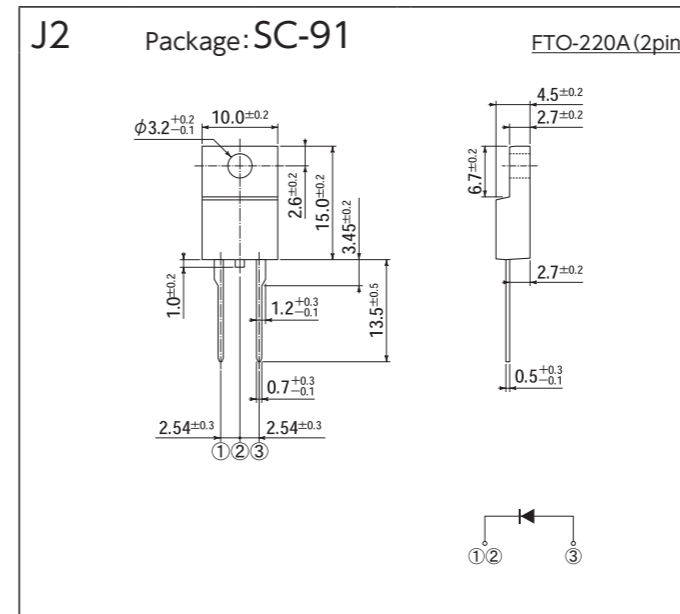
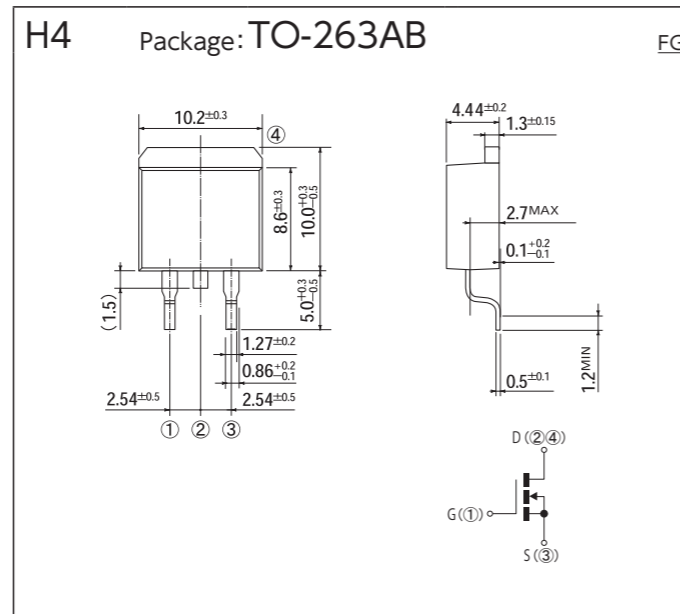
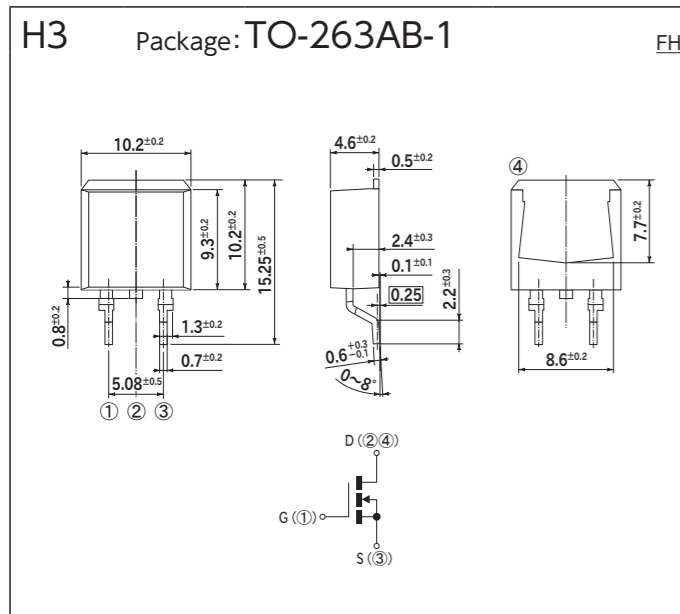
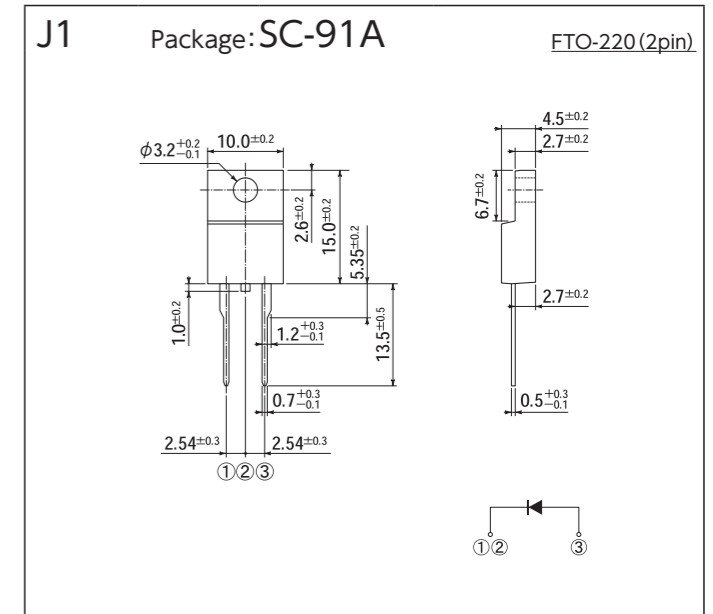
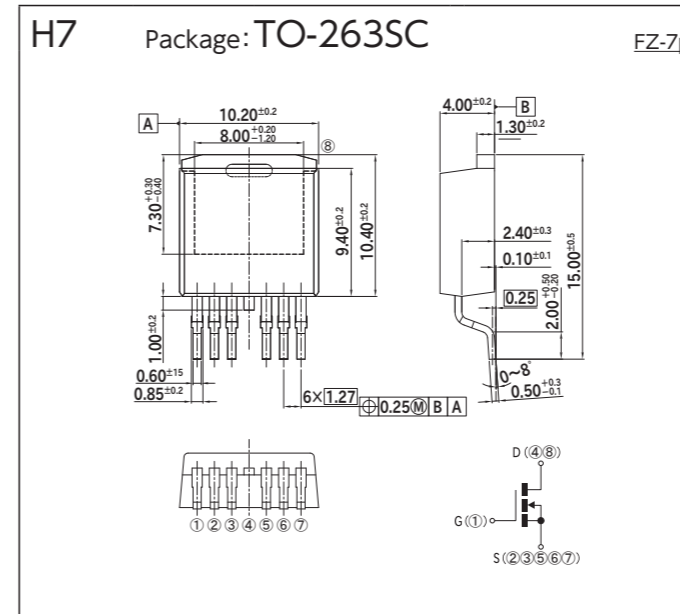
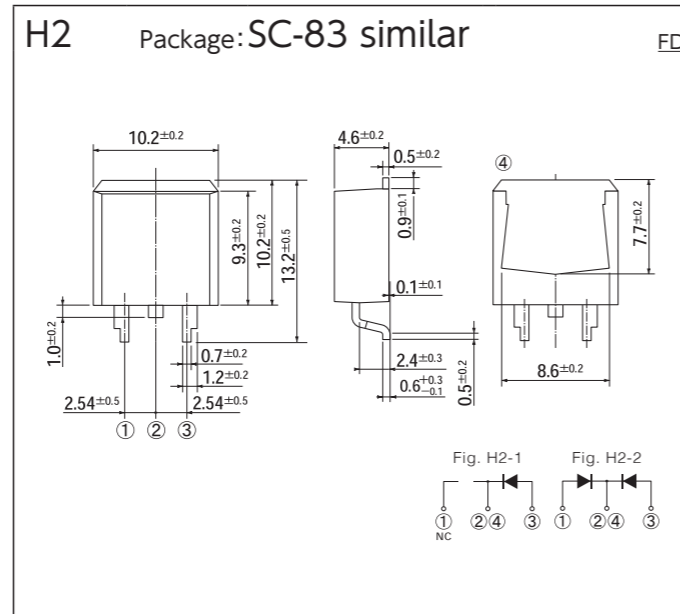
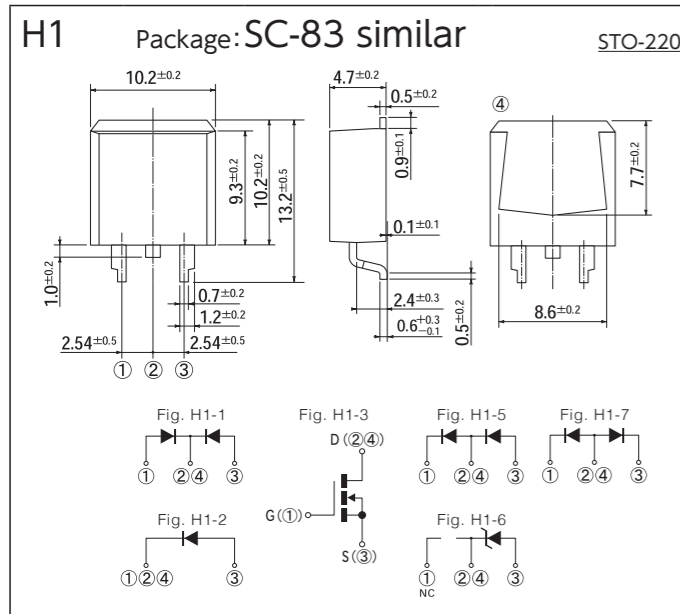
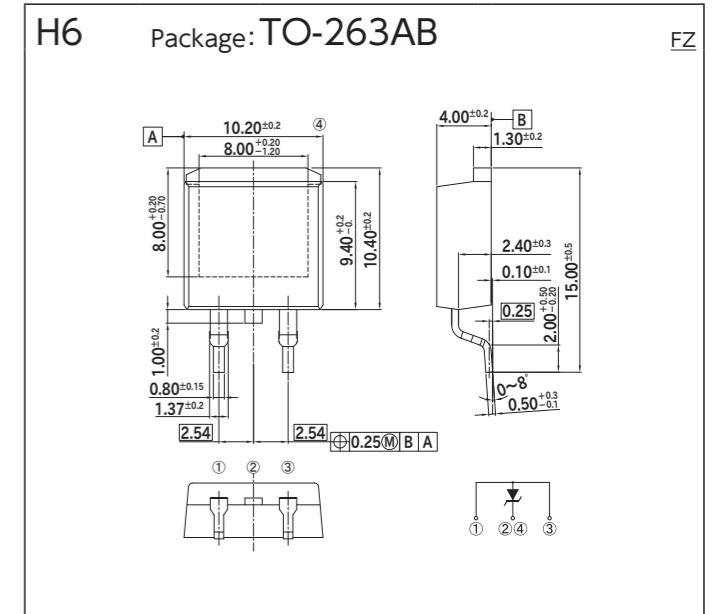
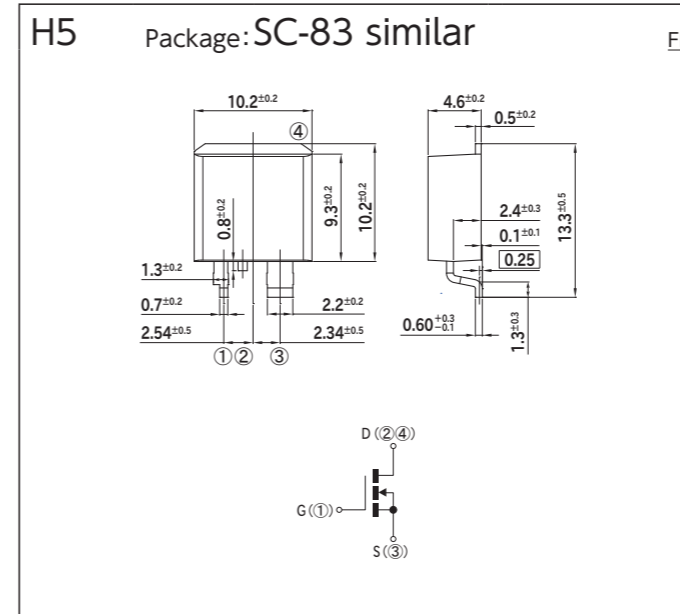
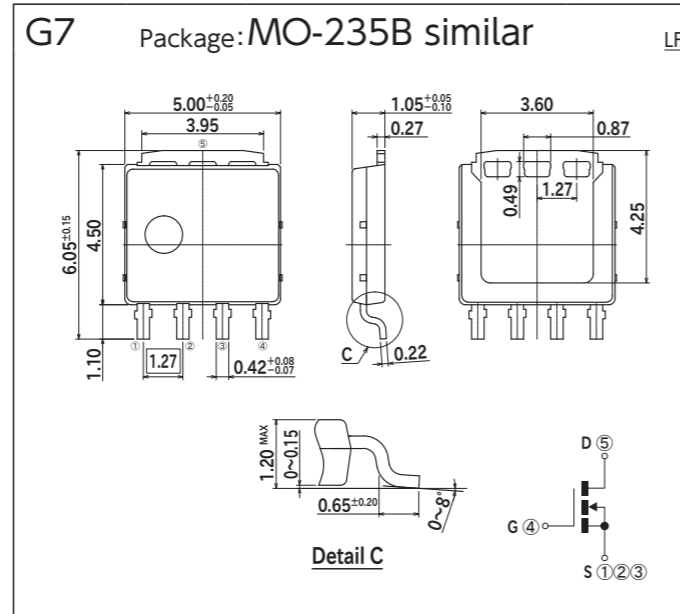
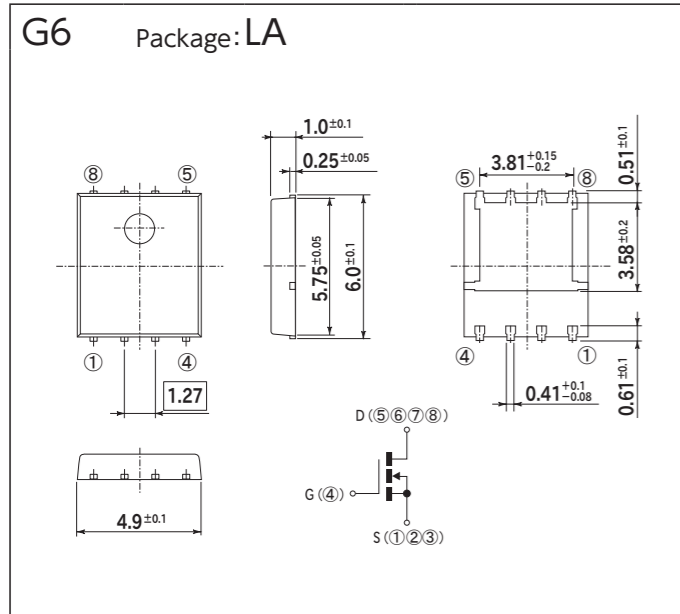

OUTLINE DIMENSIONS

[Unit:mm]

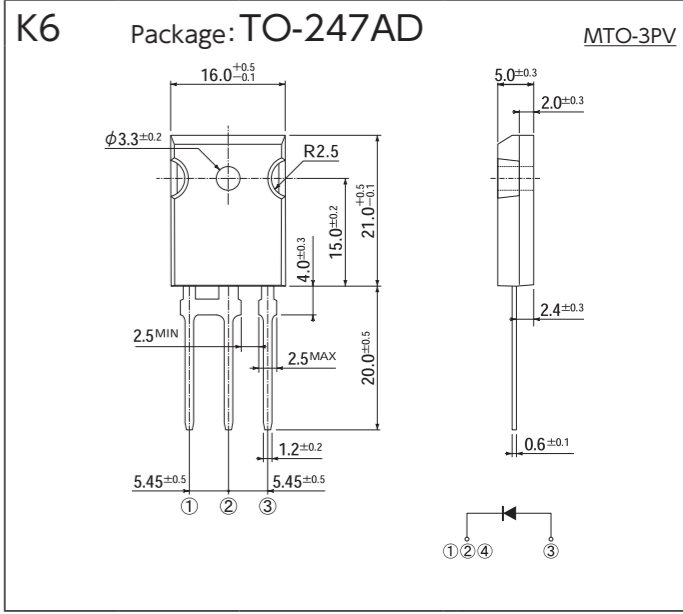
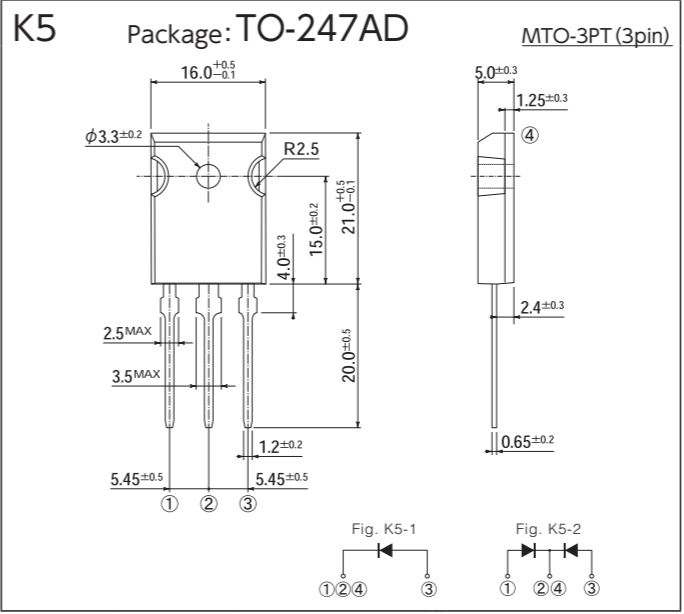
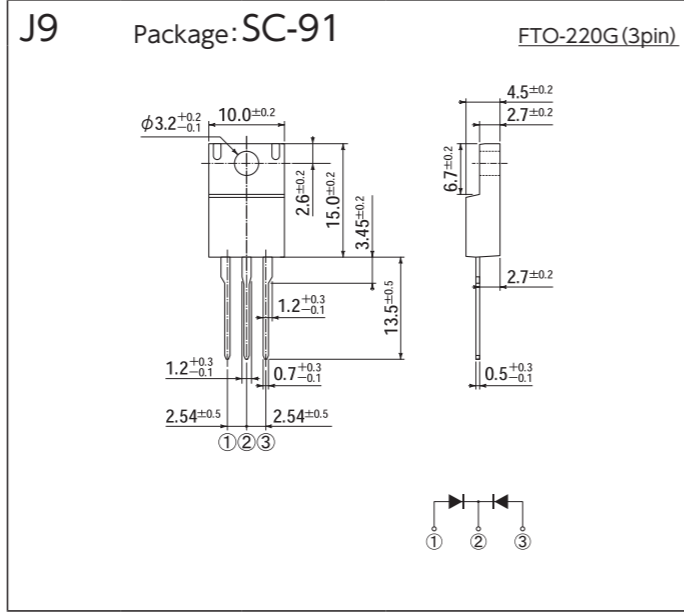
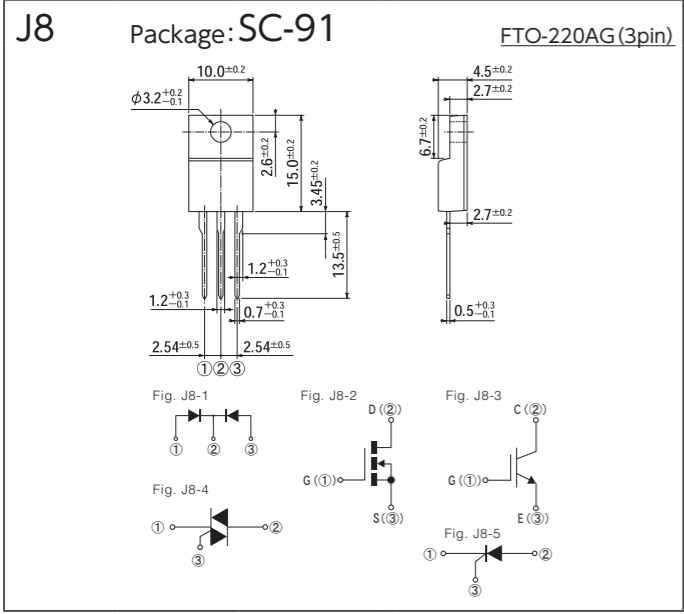
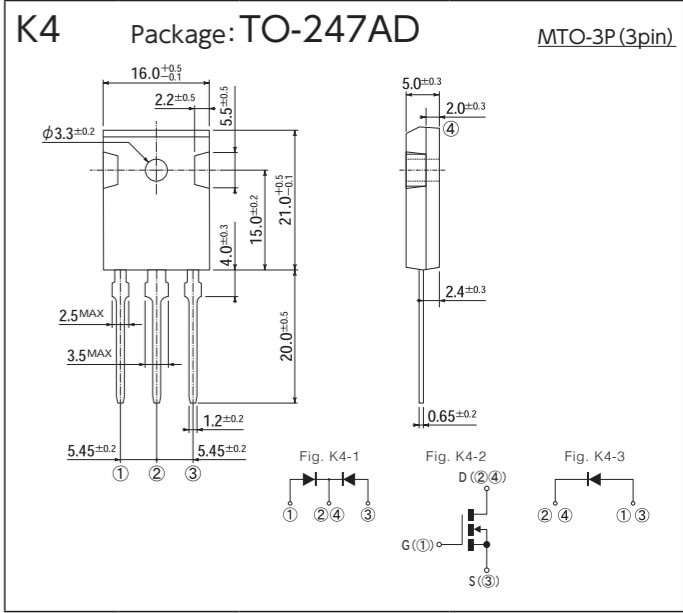
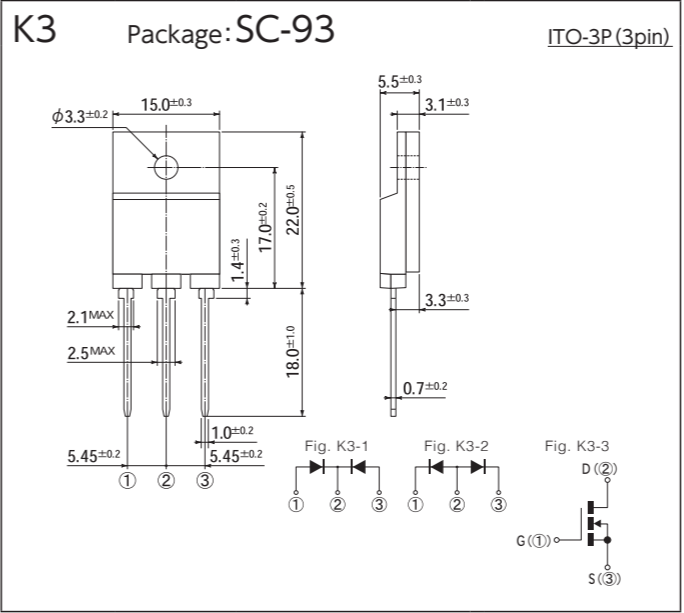
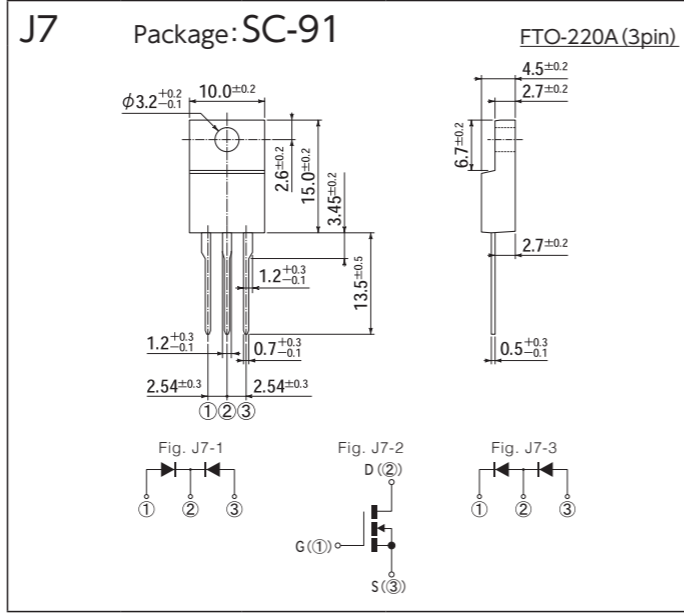
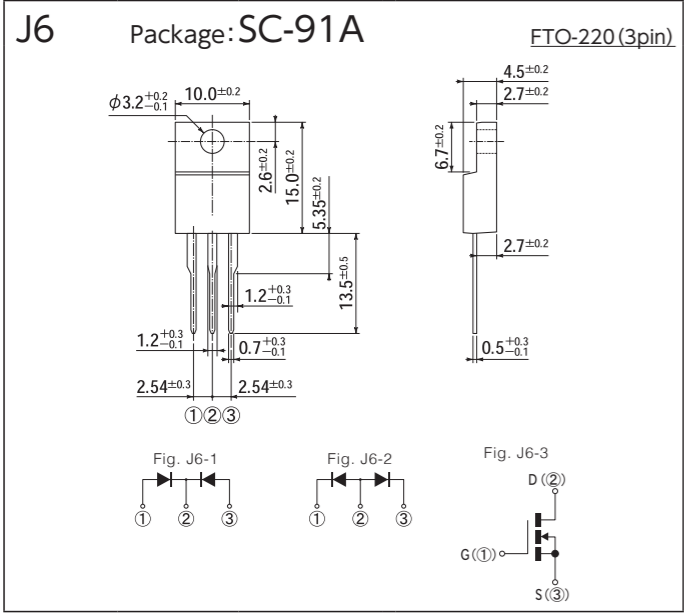
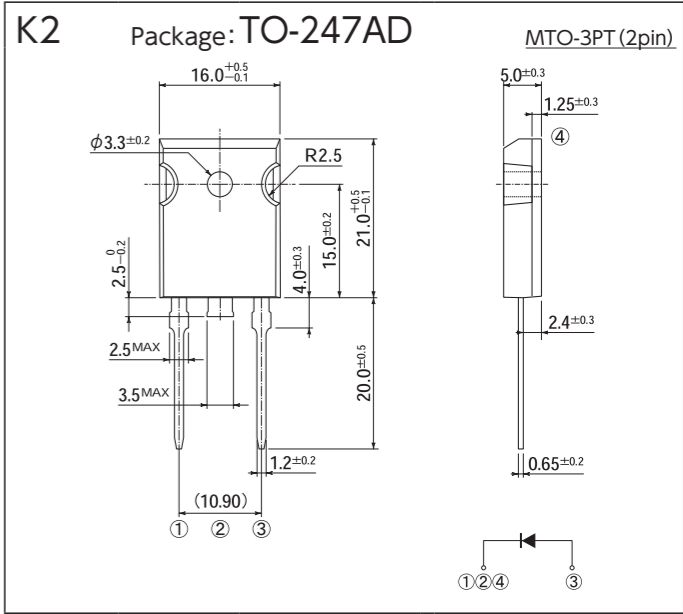
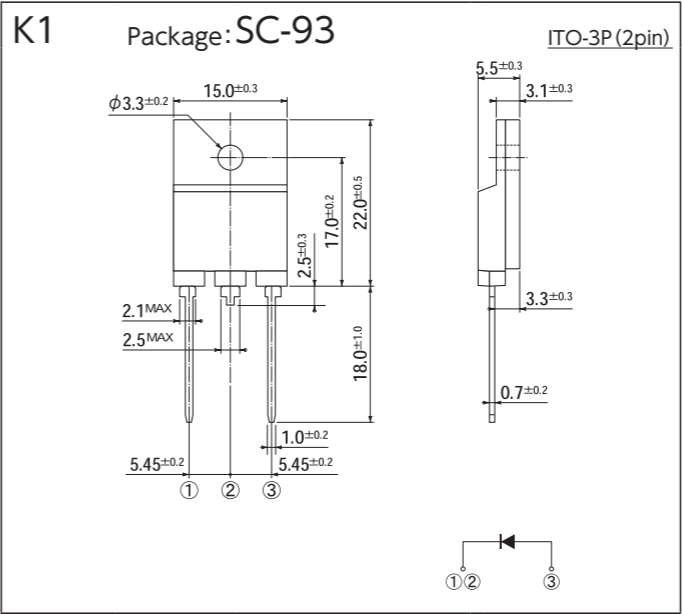
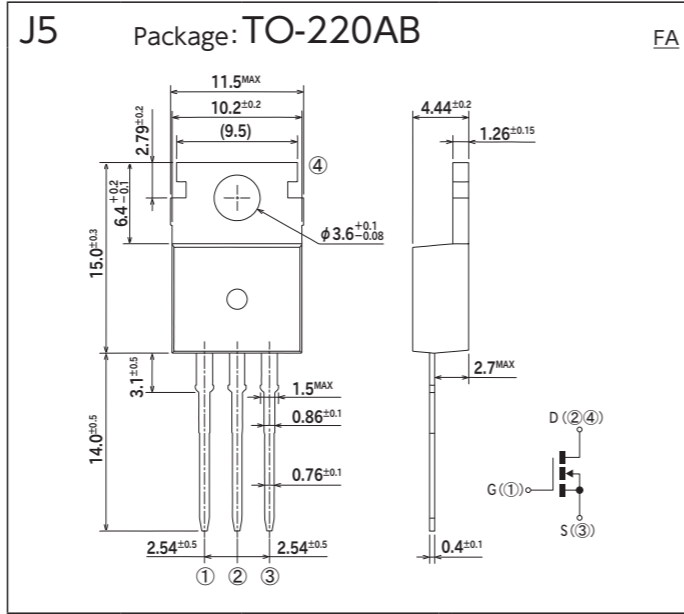
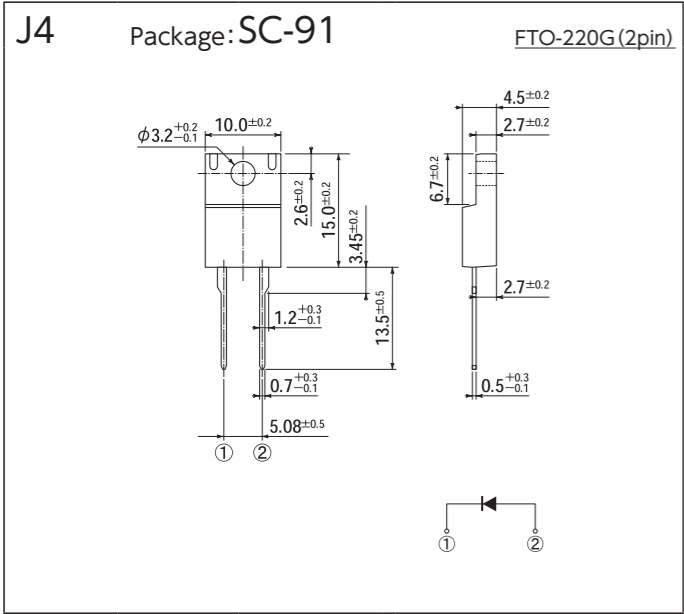

OUTLINE DIMENSIONS

[Unit:mm]

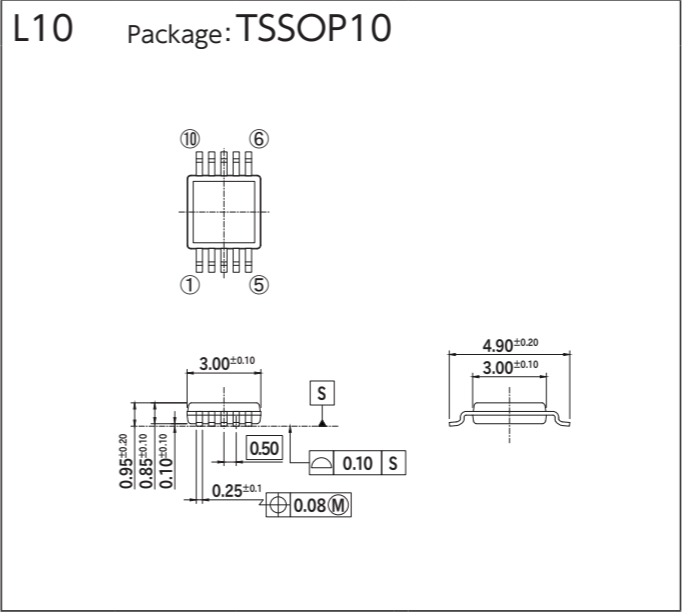
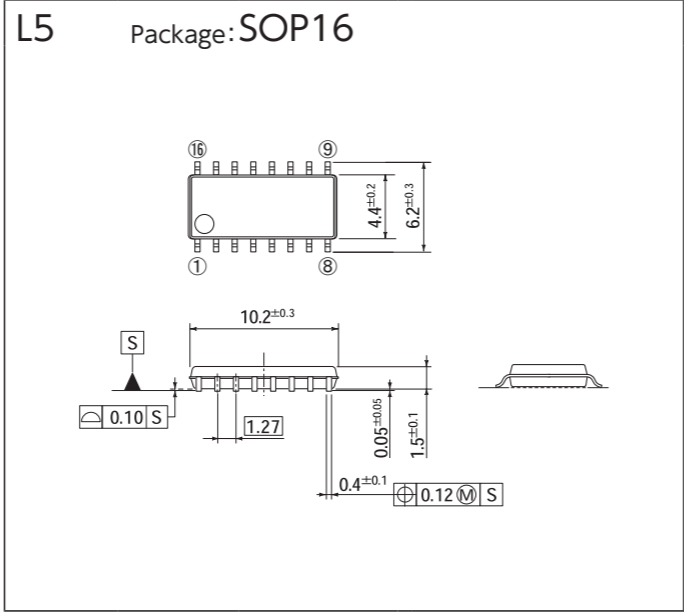
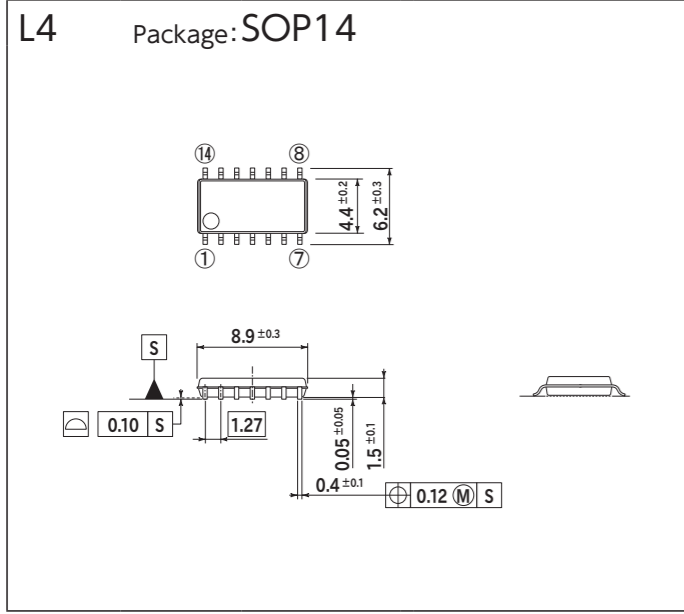
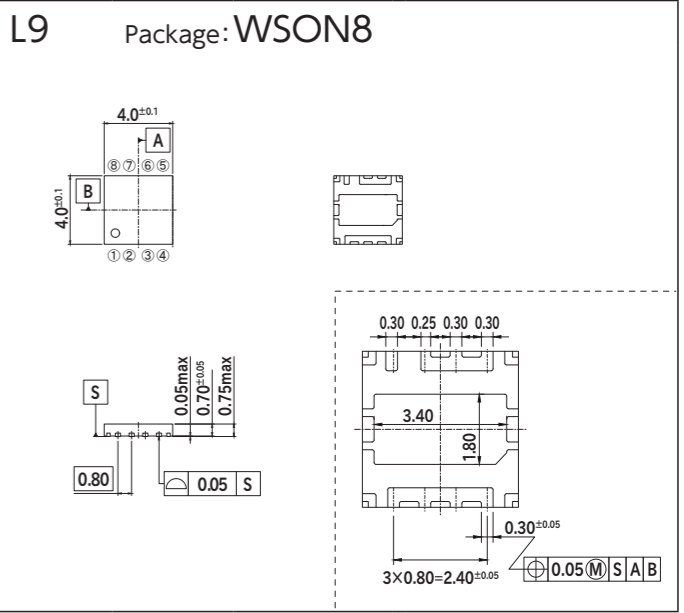
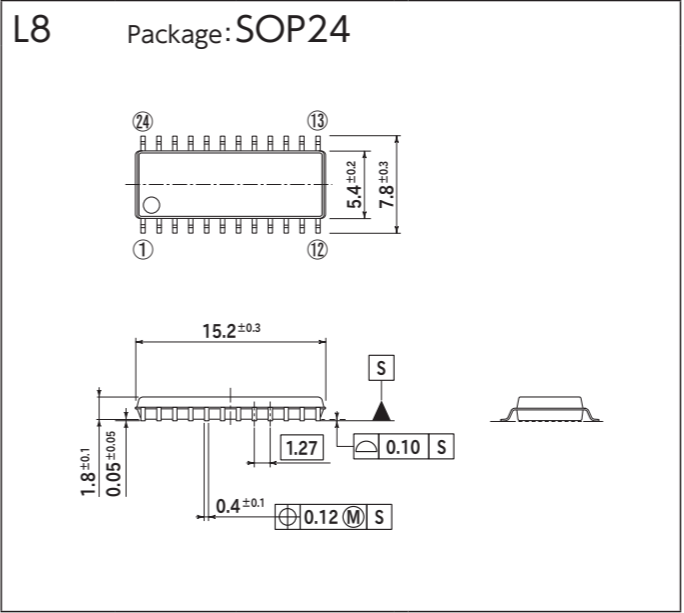
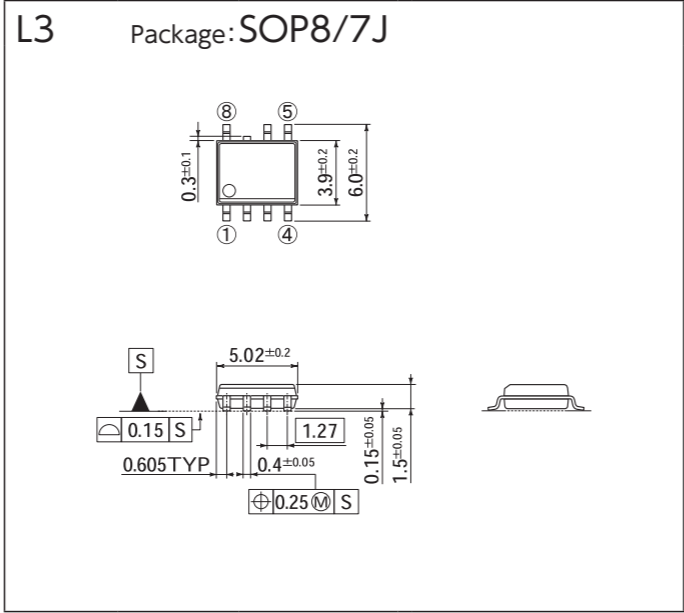
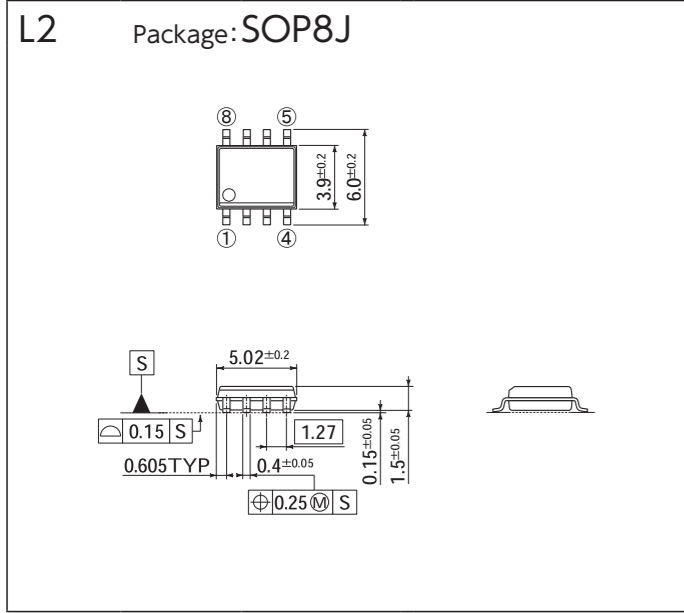
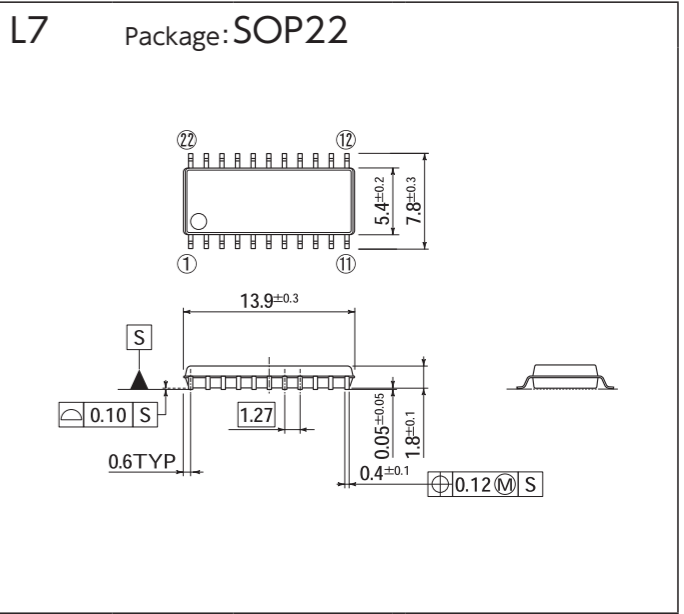
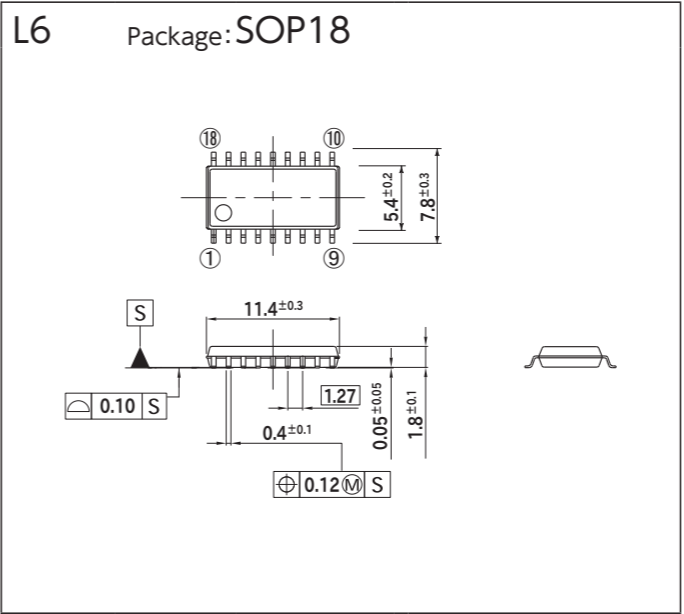
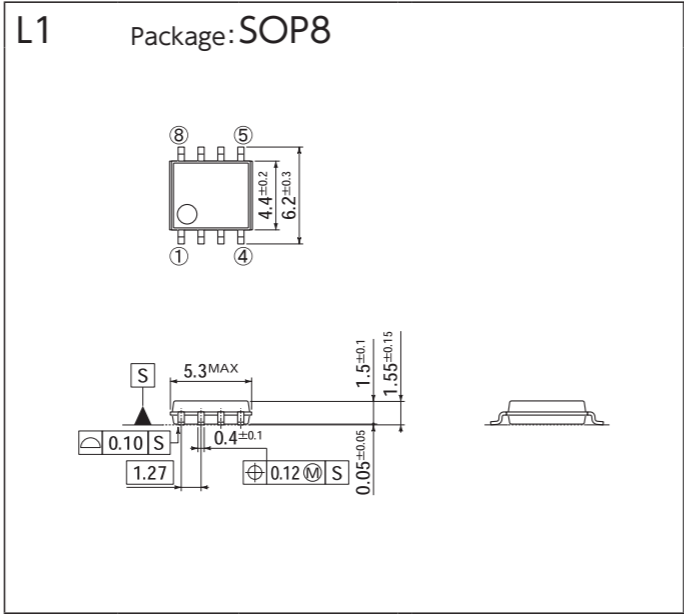
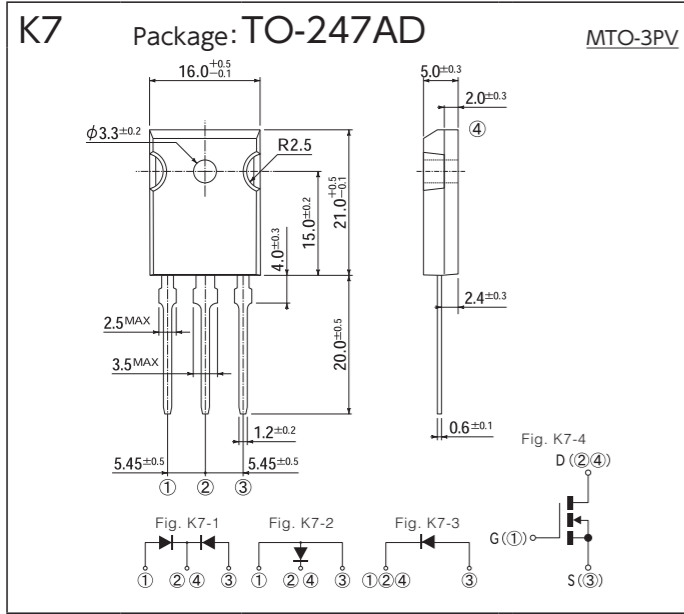

OUTLINE DIMENSIONS

NOTES

How to Order

1. Indication of Spec. Code when ordering

Please specify the Spec. Code when ordering semiconductors.
For the Spec. Code, Please refer to as follows and "PACKING SPECIFICATION".

Example Ordering THD type of S1ZB60
S1ZB60-7101

2. Spec Code

The code specifies each packing form, lead forming and terminal plate material.

Please refer to "PACKING SPECIFICATION".

Example 5 0 0 0

- Terminal forming
 - 0 : Straight terminal
 - 1 to 9 : Each number shows type of form
- Packing form
 - 0 : Standard
 - In case of surface mounting devices
 - 5, 6 : Small reel
 - 7 : Large reel
 - In case of axial device
 - 6 : Lead length 52mm (T52)
 - 7 : Lead length 26mm (T26)
- Minimum packing unit
 - 0 : Bulk, tray or taping
 - 1 : Magazine
 - 5 : Tray
 - 6 : Packed (FTO-220 Package)
- Terminal plate material
 - 3 : Ni/Pd/Au, Sn-Ag
 - 4 : Ni, Ag
 - 5 : Sn-Ag-Cu, Sn, Ag, Sn-Cu
 - 6 : Sn
 - 7 : Sn-Bi

Outline of Packing Form

1. Minimum packing unit

- Bulk : The form in which parts are inserted into plastic bags or cardboard boxes.
- Tray : The form in which parts are inserted in to containers made of resin.



- Magazine : The form in which parts are inserted into resin cartridges designated for automatic inserters.



- Taping
 - Reel (Surface mounting devices)



- Box (Axial devices)



2. Packing Box Dimensions

See the following pages for the dimensions of each cardboard box.

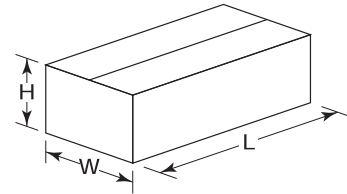

About AEC-Q101 & Automotive Grade

1. AEC-Q101

These products are based on AEC-Q101.

2. Automotive Grade

These products are produced on a designated production line qualified for internal automotive standards.

Mouser Electronics

Authorized Distributor

Click to View Pricing, Inventory, Delivery & Lifecycle Information:

Shindengen:

[D1N60-7084](#) [D1N60-7083](#) [D1N60-7070](#) [D25SC6MR-7112](#) [D25SC6MR-7100](#) [S2V60-4061](#) [D30L60-7112](#) [D30L60-7100](#) [D25SC6M-7112](#) [S1ZB60-7062](#) [S1ZB60-7072](#) [S1NB60-7062](#) [D1FP3-5103](#) [D1FS4A-5063](#) [D1FS4-5073](#) [D1FS4-5063](#) [D1FJ10-5063](#) [D1FJ4-5063](#) [D1FK60-5063](#) [D1FS6-5063](#) [D1FS4A-5103](#) [D1NL20U-7070](#) [D1NL20U-7084](#) [D1NL20U-7083](#) [D1FP3-5073](#) [D1FP3-5063](#) [S3L20U-7060](#) [S1ZB80-7102](#) [S1ZB80-7101](#) [SF8K60M-7600](#) [ST70-27MF-7072](#) [S1NB60-4062](#) [S1NB60-4101](#) [S1NB60-4102](#) [ST04-16F1-5063](#) [ST70-27F-7072](#) [D1NK60-5070](#) [D1NL20U-5070](#) [S1ZAS4-7101](#) [ST03D-82-5053](#) [DL04-18F1-5053](#) [D1NS6-5070](#) [D1NF60-5070](#) [ST04-36F1-5103](#) [S2L60-5000](#) [S20LC40UV-5100](#) [S20LC60USV-5100](#) [ST60-48MF-4072](#) [S2L40U-5000](#) [D2SBA60-7000](#) [S3V60-5061](#) [D3S6M-5061](#) [ST03-58F1-5063](#) [ST03-68F1-5063](#) [S3L60-5061](#) [D3S4M-5061](#) [D1FT15A-5053](#) [D20FD60LU-5072](#) [P100FA7R5EN-5100](#) [D1FE60-5053](#) [P26F28HP2-5600](#) [P36F28HP2-5600](#) [P60B4EL-5071](#) [P70F7R5EN-5600](#) [P8F28HP2-5600](#) [S30V80V-5000](#) [D30FDC4S-5072](#) [D1FT4-5053](#) [D20FDC10ST-5072](#) [P55F6EN-5600](#) [P60B6EN-5071](#) [D30JCT120V-7500](#) [D30FDC10ST-5072](#) [D30FDC15ST-5072](#) [D30JCB100K-7500](#) [P90FG5R5SL-5071](#) [DL04-36F1-5053](#) [S60SC4V-5100](#) [D40FDC15ST-5072](#) [ST04-39F1-5053](#) [DL04-33F1-5053](#) [P21F28HP2-5600](#) [P42F6EN-5600](#) [D1FJ4-5103](#) [D1FK60-5103](#) [D1N80-5070](#) [D1FL40U-5103](#) [D3FK60-5103](#) [DE5L60U-7101](#) [D3S6M-5000](#) [DF30JC6-7102](#) [DF15JC10-7102](#) [DF30JC4-7102](#) [DF30JC10-7102](#) [DF20LC30-7102](#) [DF20LC20US-7102](#) [DL04-18F1-5103](#) [S60JC10V-5100](#) [S3K60-5000](#) [S1WB\(A\)60-7102](#)